

1	2	3	4	5	6	7	8
REV. DESCRIPTION	DRW. CHK.	APP.	DATE				
A	RELEASE						

SPECIFICATIONS

Current Rating:
3 Amp

Insulator resistance:
5000 Megohms Min.

Contact resistance:
20 m ohms Max.

Dielectric withstanding:
AC 1000V/minute

Operating Temperature:
-40° ~ +105°C

Contact Material:
BRASS

Insulator Material:
High Temperature Thermoplastic
+Glass Fibre UL94V-0

Color: Black

Finish:
Gold, Tin or Duplex plated
Standard: Gold flash all over
Duplex plated:
Gold plated on contact area
Tin on solder area

RoHS Compliance

ORDERING INFORMATION

21X13363-XXXXXX-XXX-XXX-XXX

Material
B PBT
N Nylon-6T
L LCP

Row of plastic
Single Row

Plastic Height
3.30mm

Spacite & Pitch
0.64sq x PH2.50mm

Number of Contact
02-40

Exterior
Referenced Sheet 3/6, 4/6, 5/6, 6/6

Adjunctive Code
Referenced Sheet 2/6

Dimension
A
6/3 A/B
6/3/1.5 A/B/C

Plating Type
G Gold Plated
T Tin Plated
H Duplex Plated

Contact Plating
01 Normal
03 3μ"
05 5μ"
10 10μ"

Color
B Black
R Red
U Blue
: : : :

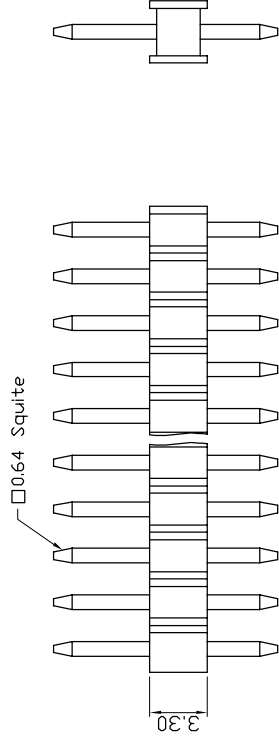
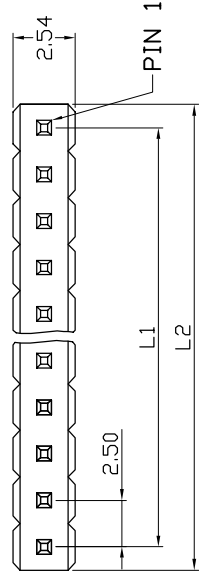

示意圖

Ref.

成品規格圖		APP.	ANGLES	±3°	SIZE	A4
TITLE	2.50mm Pin Header 13363 Series	CHK.	LINEAR	0.0 ±0.38	SCALE	NONE
PART NO	21X13363-XXXXXX-XXX-XXX-XXX	DR.		0.00±0.25	SHEET	1/6
DRW NO						
UNIT	mm(INCH)	PROJECT				
		KEN				
		96.01.04				



A B C D E F G H

1 2 3 4 5 6 7 8

REV.	DESCRIPTION	DRW.	CHK.	APP.	DATE
A	RELEASE				

ADJUNCTIVE CODE

21X13363-XXXXXX-XXX-XXX-ABCDEFMSXYZKVRWNHXXPX

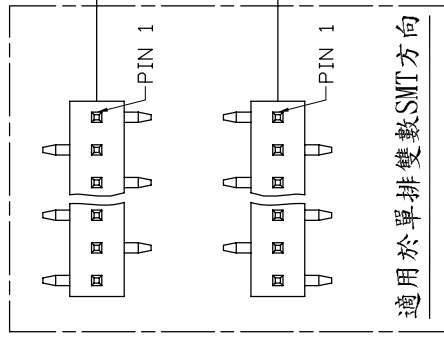

加 CAP

加 圓片端子

加 WAFER

加 Mini Jumper

彎角 or SMT+DIP

CUTTER

塑膠彩色印刷

高低針

跳PIN

成品兩側打Kink

磷銅端子

紅銅端子

Ref.

成品規格圖		APP.	ANGLES	±3°	SIZE	A4
TITLE	2.50mm Pin Header 13363 Series	CHK.	LINEAR	0.0 ±0.38	SCALE	NONE
PART NO	21X13363-XXXXXX-XXX-XXX-XXX			0.00±0.25	SHEET	2/6
DRW NO		DR.	KEN			
UNIT	mm(INCH)	PROJECT	96.01.04			





A B C D E F G H

1 2 3 4 5 6 7 8

1 2 3 4 5 6 7 8

EXTERIOR

REV.	DESCRIPTION	DRW.	CHK.	APP.	DATE
A	RELEASE				

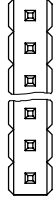
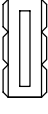
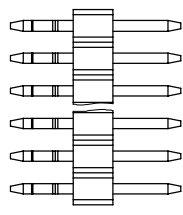
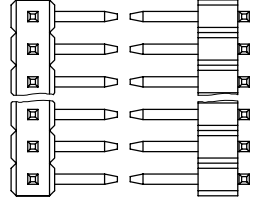
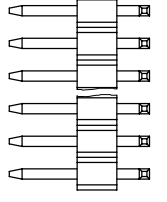
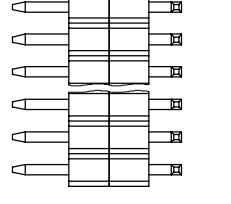
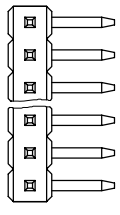
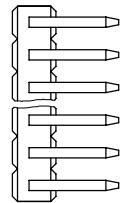
 S10	 S20	 S22	 A10
 J10	 D00	 D10	 D20
 D22	 R00	<div style="border: 1px solid black; padding: 10px; width: fit-content; margin: 0 auto;"> <h2 style="margin: 0;">Ref.</h2> </div>	

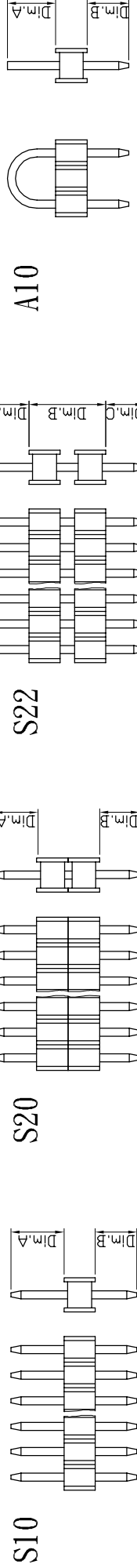

21X13363-XXS10X-XXX-A/B-XXX Exterior Dimension

21X13363-XXS20X-XXX-A/B-XXX Exterior Dimension

21X13363-XXS22X-XXX-A/B/C-XXX Exterior Dimension

21X13363-XXA10X-XXX-A/B-XXX Exterior Dimension

21X13363-XXJ10X-XXX-A-XXX Exterior Dimension

21X13363-XXD00X-XXX-A/B-XXX Exterior Dimension

21X13363-XXD10X-XXX-A/B/C-XXX Exterior Dimension

21X13363-XXD20X-XXX-A/B/C-XXX Exterior Dimension

21X13363-XXR00X-XXX-A/B-XXX Exterior Dimension

成品規格圖		APP.	ANGLES	±3°	SIZE	A4
TITLE	2.50mm Pin Header 13363 Series	CHK.	LINEAR	0.0 ±0.38	SCALE	NONE
PART NO	21X13363-XXXXXX-XXX-XXX-XXX			0.00±0.25	SHEET	3/6
DRW NO		DR.				
UNIT	mm(INCH)	PROJECT				



1 2 3 4 5 6 7 8

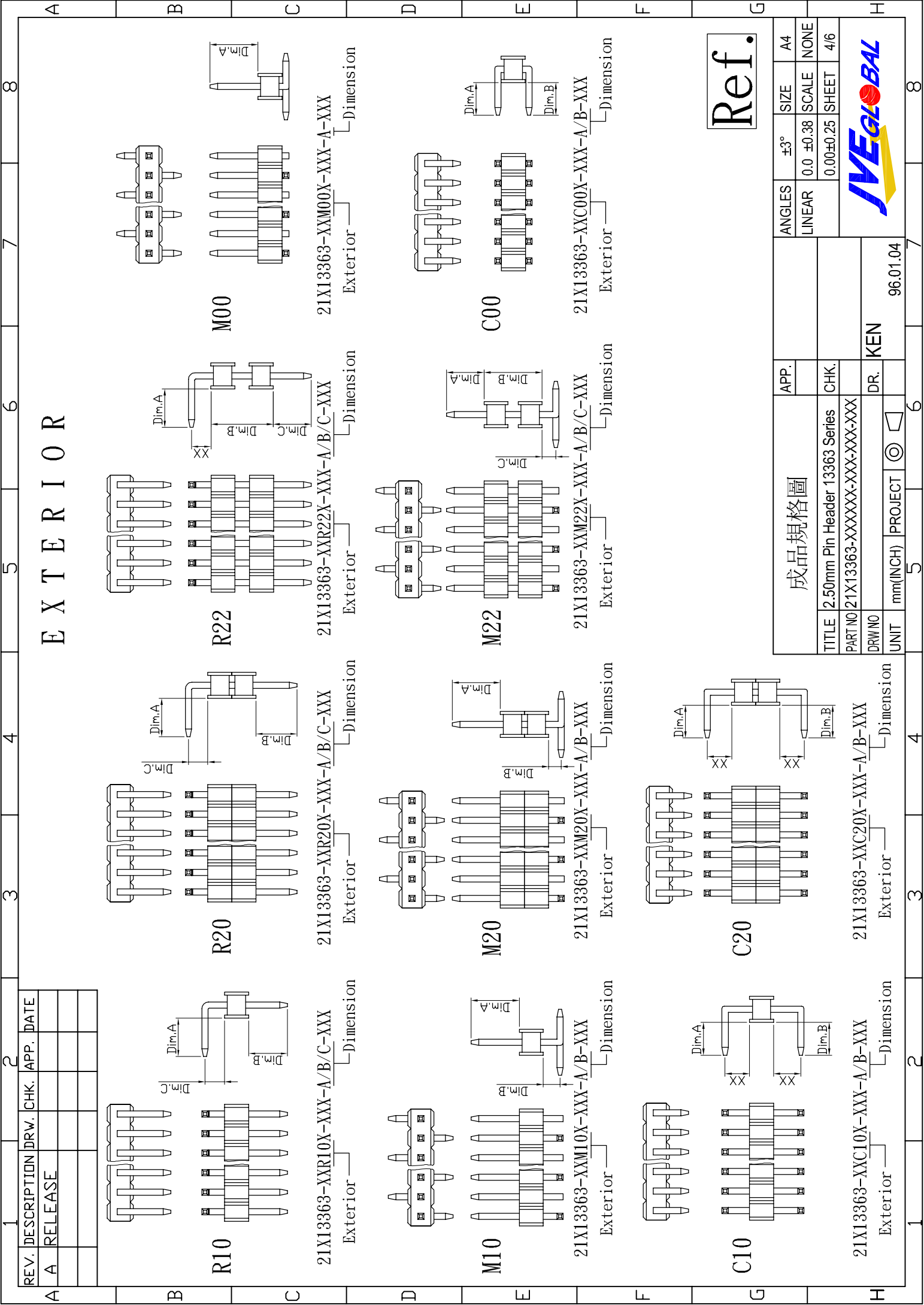

EXTERIOR

REV.	DESCRIPTION	DRW.	CHK.	APP.	DATE
A	RELEASE				

R10

21X13363-XXR10X-XXX-A/B/C-XXX

Exterior

Dimension

R20

21X13363-XXR20X-XXX-A/B/C-XXX

Exterior

Dimension

R22

21X13363-XXR22X-XXX-A/B/C-XXX

Exterior

Dimension

M00

21X13363-XXM00X-XXX-A-XXX

Exterior

Dimension

M10

21X13363-XXM10X-XXX-A/B-XXX

Exterior

Dimension

M20

21X13363-XXM20X-XXX-A/B-XXX

Exterior

Dimension

M22

21X13363-XXM22X-XXX-A/B/C-XXX

Exterior

Dimension

C00

21X13363-XXC00X-XXX-A/B-XXX

Exterior

Dimension

C10

21X13363-XXC10X-XXX-A/B-XXX

Exterior

Dimension

C20

21X13363-XXC20X-XXX-A/B-XXX

Exterior

Dimension

Ref.

成品規格圖		APP.	ANGLES	±3°	SIZE	A4
TITLE 2.50mm Pin Header 13363 Series		CHK.	LINEAR	0.0	±0.38	NONE
PART NO 21X13363-XXXXXX-XXX-A/B/C-XXX				0.00	±0.25	4/6
DRW NO		DR.	KEN			
UNIT mm(INCH)		PROJECT	96.01.04			



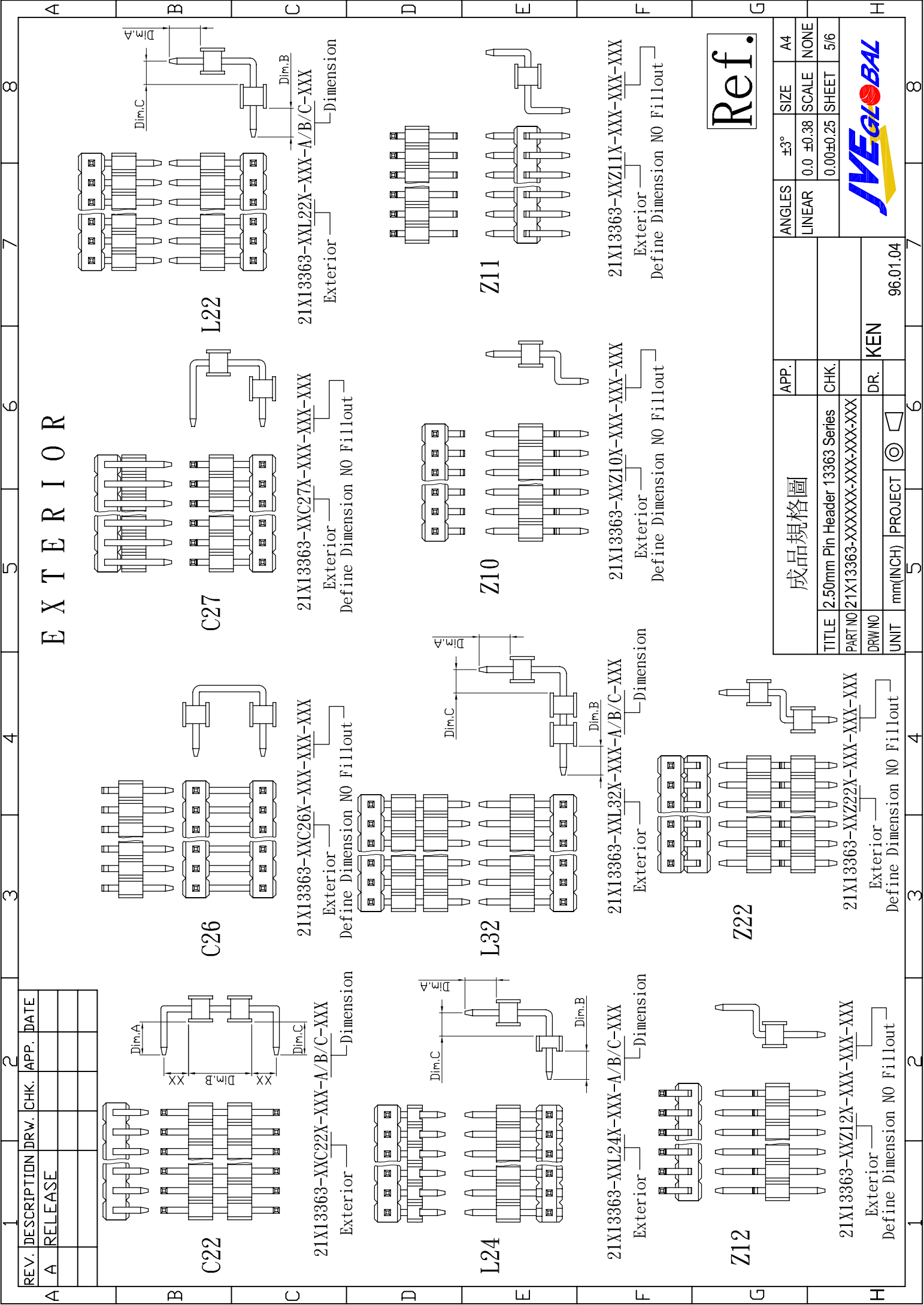

EXTERIOR

REV.	DESCRIPTION	DRW.	CHK.	APP.	DATE
A	RELEASE				

Ref.

成品規格圖		APP.	ANGLES	±3°	SIZE	A4
TITLE	2.50mm Pin Header 13363 Series	CHK.	LINEAR	0.0	±0.38	NONE
PART NO	21X13363-XXXXXX-XXX-XXX-XXX			0.00±0.25		SHEET 5/6
DRW NO		DR.	KEN		96.01.04	
UNIT	mm(INCH)	PROJECT	◎		7	



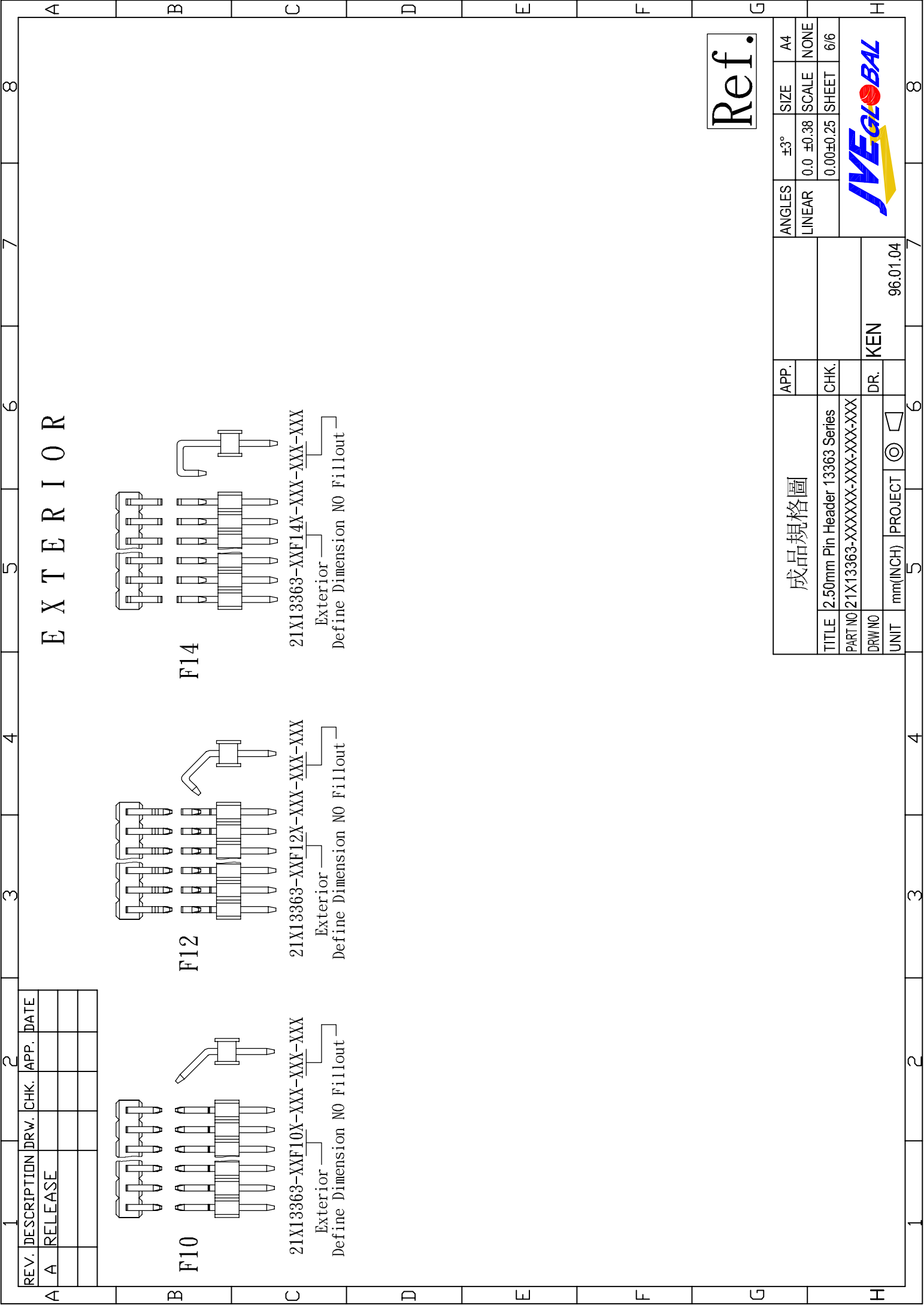

REV.	DESCRIPTION	DRW.	CHK.	APP.	DATE
A	RELEASE				

F10

21X13363-XXF10X-XXX-XXX-XXX
 Exterior
 Define Dimension NO Fillout

F12

21X13363-XXF12X-XXX-XXX-XXX
 Exterior
 Define Dimension NO Fillout

F14

21X13363-XXF14X-XXX-XXX-XXX
 Exterior
 Define Dimension NO Fillout

EXTERIOR

Ref.

ANGLES		±3°	SIZE	A4
LINEAR		0.0 ±0.38	SCALE	NONE
		0.00±0.25	SHEET	6/6
APP.				
CHK.				
DR.		KEN		
PROJECT		96.01.04		
UNIT		mm(INCH)		
TITLE		2.50mm Pin Header 13363 Series		
PART NO		21X13363-XXXXXXXX-XXX-XXX-XXX		
DRW NO				
DR.		KEN		

成品規格圖

