

REV.	DESCRIPTION	DRW.	CHK.	APP.	DATE
A	RELEASE				

SPECIFICATIONS

Current Rating:
1 Amp

Insulator resistance:
1000 Megohms Min.

Contact resistance:
25 m ohms Max.

Dielectric withstanding:
AC 500V/minute

Operating Temperature:
-40° ~ +105°C

Contact Material:
BRASS

Insulator Material:
High Temperature Thermoplastic
+Glass Fibre UL94V-0

Color: Black

Finish:
Gold, Tin or Duplex plated
Standard: Gold flash all over
Duplex plated:
Gold plated on contact area
Tin on solder area

RoHS Compliance

ORDERING INFORMATION

21X22050-XXXXXX-XXX-XXX-XXX

Material
B PBT
N Nylon-6T
L LCP

Row of plastic
Double Row

Plastic Height
1.50mm

Squite & Pitch
0.50sq x PH2.00x2.00mm

Number of Contact
04-80

Exterior
Referenced Sheet 3/6, 4/6, 5/6, 6/6

Adjunctive Code
Referenced Sheet 2/6

Dimension
A
6/3
A/B
6/3/1.5 A/B/C

Plating Type
G Gold Plated
T Tin Plated
H Duplex Plated

Contact Plating
01 Normal
03 3µ"
05 5µ"
10 10µ"

Color
B Black
R Red
U Blue
: : : : :

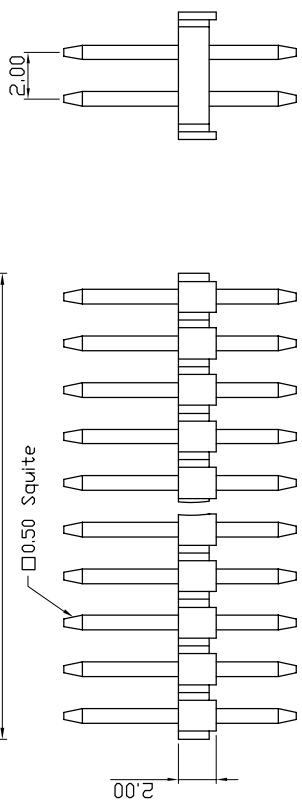
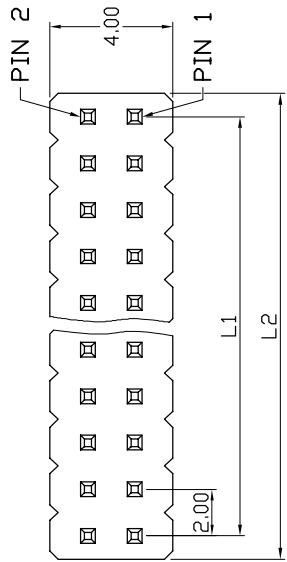

示意圖

Ref.

Cir-cuits	Dimension mm
L1	L2
2X2	4.00
2X3	6.00
2X4	8.00
2X5	10.00
2X6	12.00
2X7	14.00
2X8	16.00
2X9	18.00
2X10	20.00
2X11	22.00
2X12	24.00
2X13	26.00
2X14	28.00
2X15	30.00
2X16	32.00
2X17	34.00
2X18	36.00
2X19	38.00
2X20	40.00
2X21	42.00
2X22	44.00
2X23	46.00
2X24	48.00
2X25	50.00
2X26	52.00
2X27	54.00
2X28	56.00
2X29	58.00
2X30	60.00
2X31	62.00
2X32	64.00
2X33	66.00
2X34	68.00
2X35	70.00
2X36	72.00
2X37	74.00
2X38	76.00
2X39	78.00
2X40	80.00

ANGLES	±3°	SIZE	A4
LINEAR	0.0 ±0.38	SCALE	NONE
	0.00±0.25	SHEET	1/6

APP.

CHK.

DR.

PROJECT

UNIT mm(INCH)

96.01.04

KEN



REV.	DESCRIPTION	DRW.	CHK.	APP.	DATE
A	RELEASE				

ADJUNCTIVE CODE

21X22050-XXXXXX-XXX-XXX-ABCDEFMSXYZKVRWNHXXPX

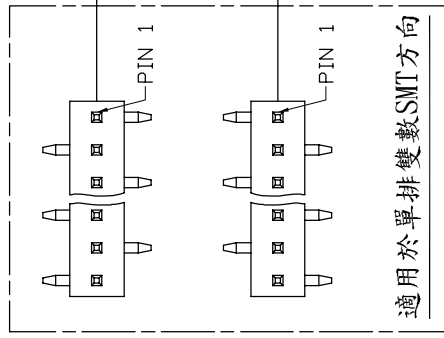

- 加 CAP
- 加 圓片端子
- 加 WAFER
- 加 Mini Jumper
- 彎角 or SMT+DIP

塑膠彩色印刷

高低針

跳PIN

成品兩側打Kink

磷銅端子

紅銅端子

CUTTER

成品規格圖		APP.	ANGLES	±3°	SIZE	A4
TITLE 2.00x2.00mm Pin Header 22050 Series		CHK.	LINEAR	0.0 ±0.38	SCALE	NONE
PART NO 21X22050-XXXXXX-XXX-XXX-XXX		DR.		0.00±0.25	SHEET	2/6
UNIT mm(INCH)		PROJECT	◎			
		KEN				
		96.01.04				

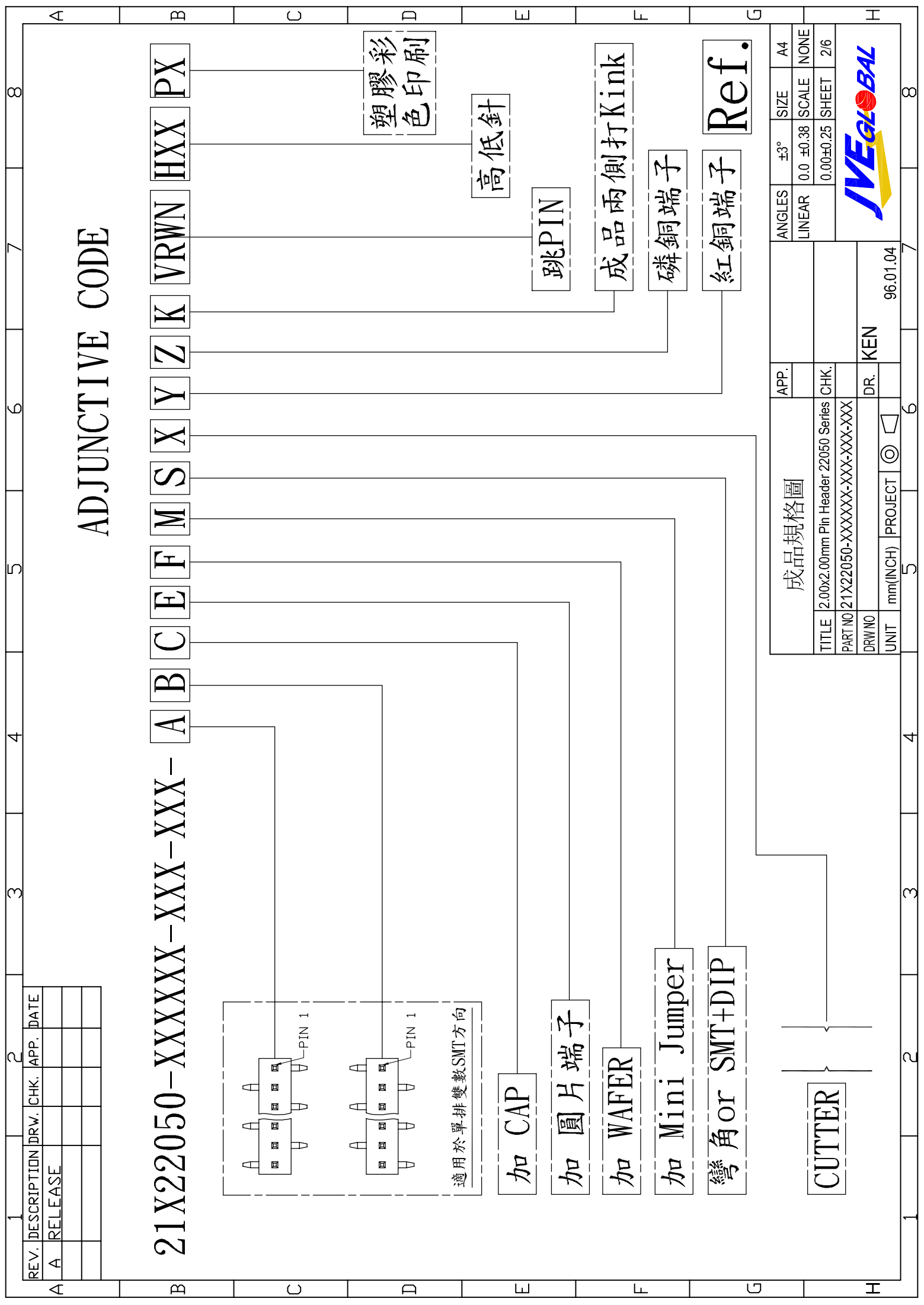

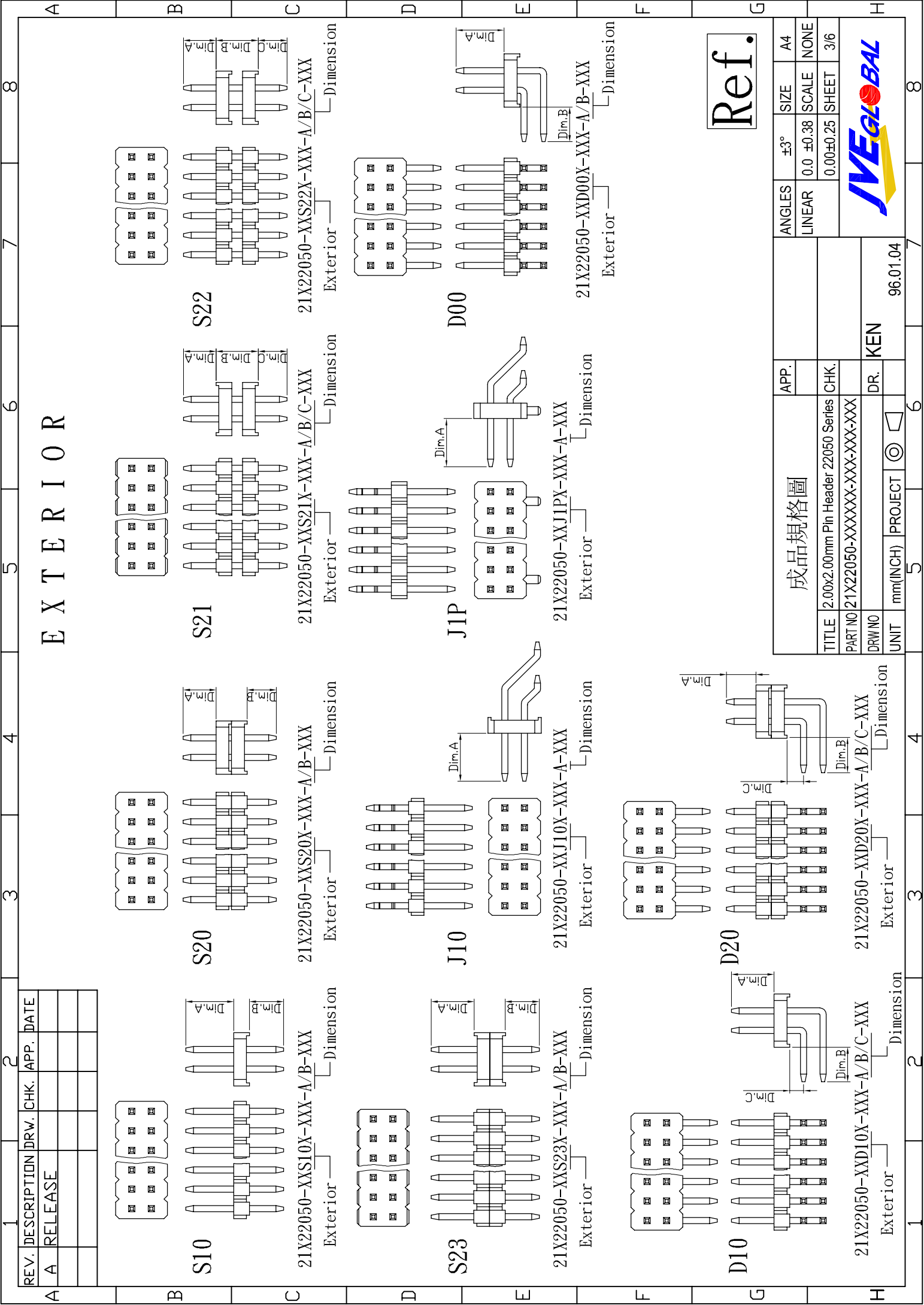

E X T E R I O R

REV.	DESCRIPTION	DRW.	CHK.	APP.	DATE
A	RELEASE				

Ref.

成品規格圖		APP.	ANGLES	±3°	SIZE	A4
TITLE 2.00x2.00mm Pin Header 22050 Series		CHK.	LINEAR	0.0	±0.38	NONE
PART NO 21X22050-XXXXXX-A/B/C-XXX				0.00	±0.25	3/6
DRW NO		DR.	KEN			
UNIT	mm(INCH)	PROJECT				



1 2 3 4 5 6 7 8

A B C D E F G H

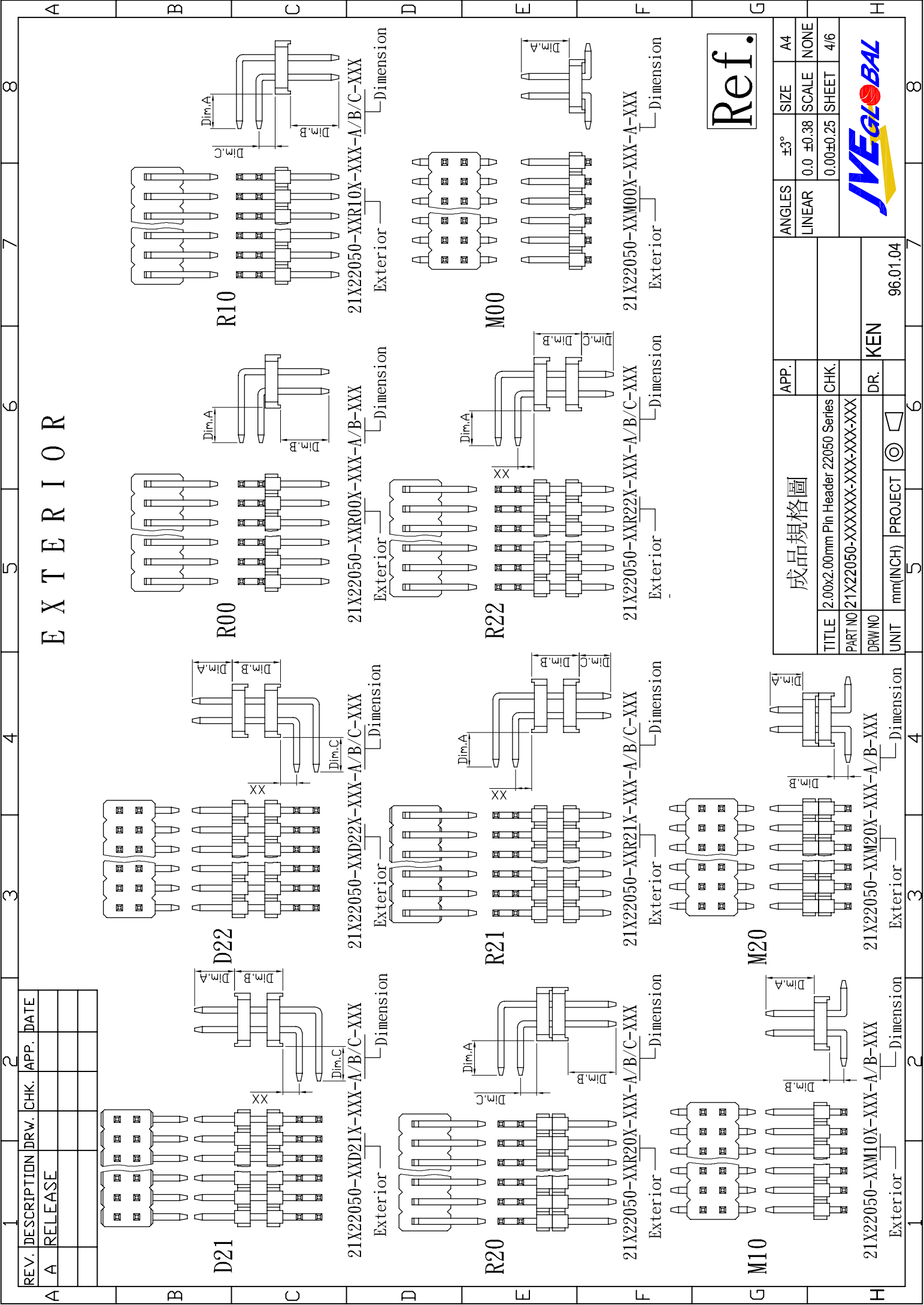

E X T E R I O R

REV.	DESCRIPTION	DRW.	CHK.	APP.	DATE
A	RELEASE				

Ref.

成品規格圖		APP.	ANGLES	±3°	SIZE	A4		
TITLE		2.00x2.00mm Pin Header 22050 Series		LINEAR	0.0 ±0.38	SCALE	NONE	
PART NO		21X22050-XXXXXX-A/B/C-XXX		CHK.		0.00±0.25	SHEET	4/6
DRW NO				DR.		KEN		
UNIT		mm(INCH)		PROJECT		96.01.04		



21X22050-XXM10X-XXX-A/B-XXX

21X22050-XXM20X-XXX-A/B-XXX

21X22050-XXR20X-XXX-A/B/C-XXX

21X22050-XXR21X-XXX-A/B/C-XXX

21X22050-XXR22X-XXX-A/B/C-XXX

21X22050-XXM00X-XXX-A-XXX

21X22050-XXD21X-XXX-A/B/C-XXX

21X22050-XXD22X-XXX-A/B/C-XXX

21X22050-XXR00X-XXX-A/B-XXX

21X22050-XXR10X-XXX-A/B/C-XXX

D21

D22

R00

R10

R20

R21

R22

M00

M10

M20

1

2

3

4

5

6

7

8

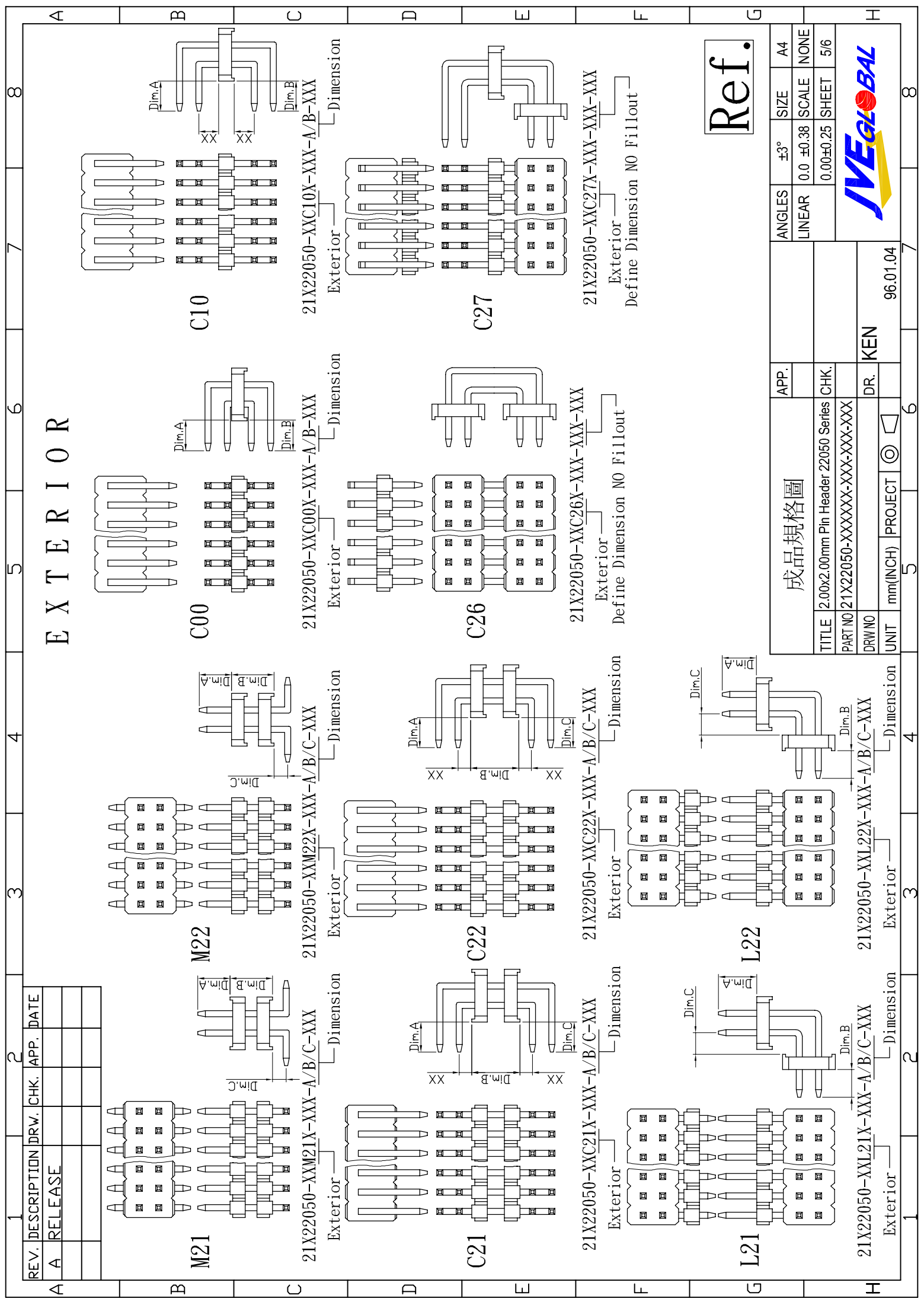

EXTERIOR

REV.	DESCRIPTION	DRW.	CHK.	APP.	DATE
A	RELEASE				

Ref.

成品規格圖		APP.	ANGLES	±3°	SIZE	A4
TITLE	2.00x2.00mm Pin Header 22050 Series	CHK.	LINEAR	0.0 ±0.38	SCALE	NONE
PART NO	21X22050-XXXXXX-XXX-XXX-XXX			0.00±0.25	SHEET	5/6
DRW NO		DR.	KEN			
UNIT	mm(INCH)	PROJECT	96.01.04			



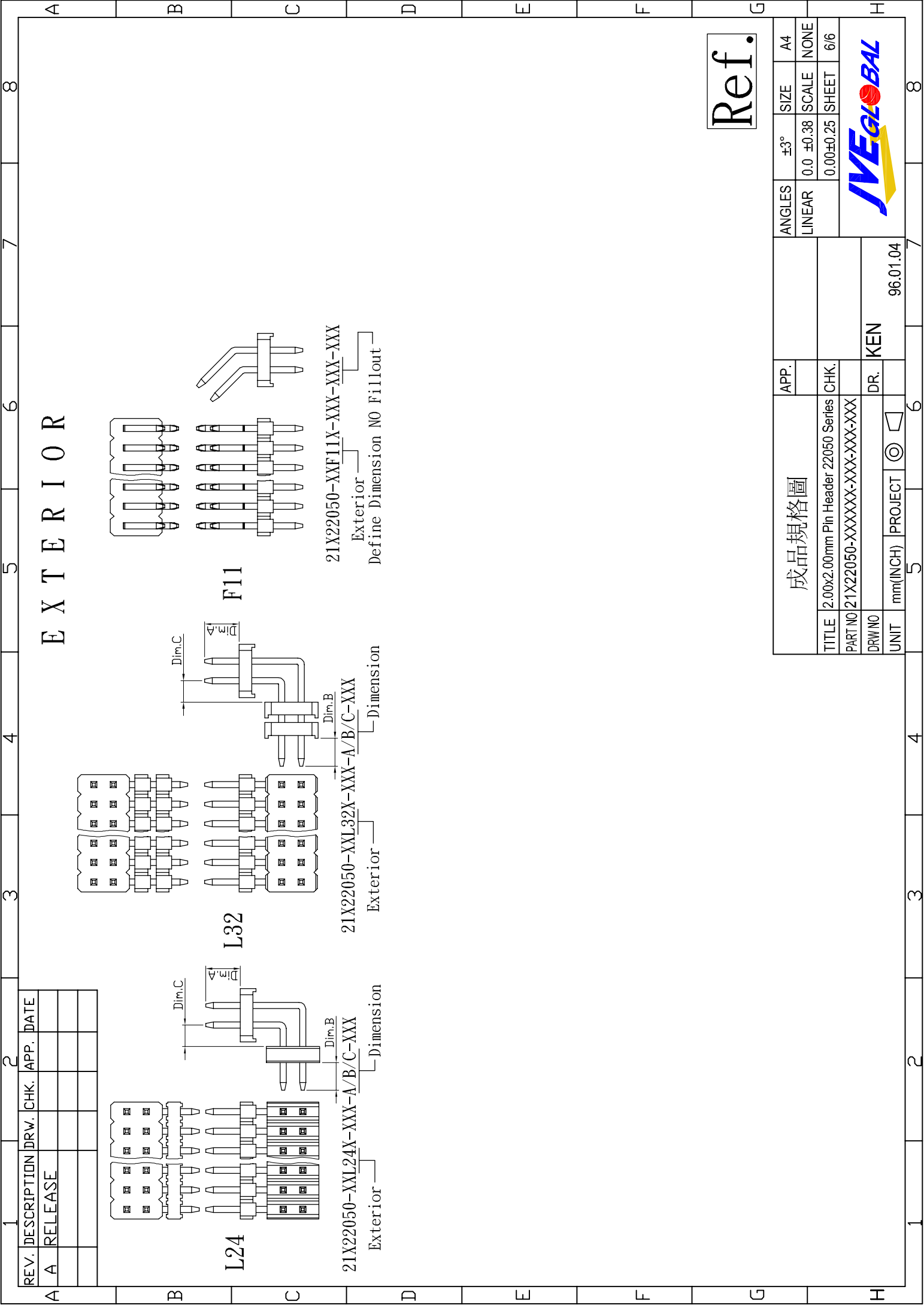

REV.	DESCRIPTION	DRW.	CHK.	APP.	DATE
A	RELEASE				

EXTERIOR

Ref.

成品規格圖		APP.	ANGLES	±3°	SIZE	A4
TITLE	2.00x2.00mm Pin Header 22050 Series	CHK.	LINEAR	0.0 ±0.38	SCALE	NONE
PART NO	21X22050-XXXXXX-A/B/C-XXX			0.00±0.25	SHEET	6/6
DRW NO		DR.	KEN			
UNIT	mm(INCH)	PROJECT	96.01.04			

