

REV.	DESCRIPTION	DRW.	CHK.	APP.	DATE
A	RELEASE				

SPECIFICATIONS

Current Rating:
 1 Amp
 Insulator resistance:
 1000 Megohms Min.
 Contact resistance:
 20 m ohms Max.
 Dielectric withstanding:
 AC 500V/minute
 Operating Temperature:
 -40° ~ +105°C
 Contact Material:
 BRASS
 Insulator Material:
 High Temperature Thermoplastic
 +Glass Fibre UL94V-0
 Color: Black
 Finish:
 Gold, Tin or Duplex plated
 Standard: Gold flash all over
 Duplex plated:
 Gold plated on contact area
 Tin on solder area

RoHS Compliance

ORDERING INFORMATION

21X21740-XXXXXX-XXX-XXX-XXX

Material: B PBT, N Nylon-6T, L LCP
 Row of plastic Double Row
 Plastic Height: 1.70mm
 Spacing & Pitch: 0.40sq x PH. 27x1.27mm
 Number of Contact: 04-80
 Exterior: Referenced Sheet 3/6, 4/6, 5/6, 6/6
 Adjunctive Code Referenced Sheet 2/6
 Dimension: 6, 6/3, A/B, 6/3/1.5, A/B/C
 Plating Type: G Gold Plated, T Tin Plated, H Duplex Plated
 Contact Plating: 01 Normal, 03 3µ", 05 5µ", 10 10µ"
 Color: B Black, R Red, U Blue, ...

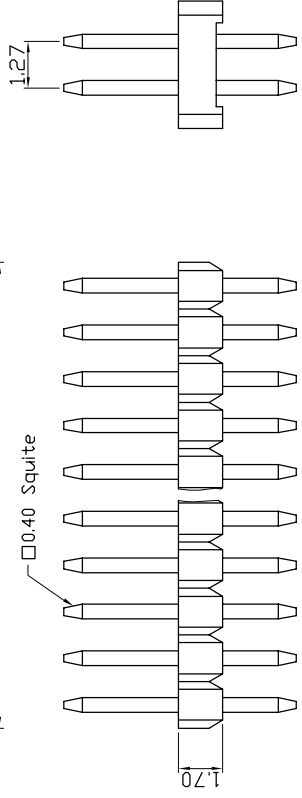
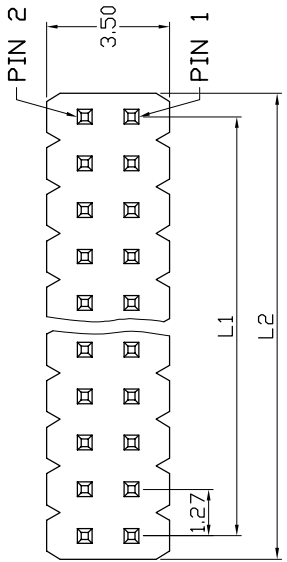

示意圖

Ref.

Circuits	Dimension mm
L1	L2
2x2	1.27
2x3	2.54
2x4	3.81
2x5	5.08
2x6	6.35
2x7	7.62
2x8	8.89
2x9	10.16
2x10	11.43
2x11	12.70
2x12	13.97
2x13	15.24
2x14	16.51
2x15	17.78
2x16	19.05
2x17	20.32
2x18	21.59
2x19	22.86
2x20	24.13
2x21	25.40
2x22	26.67
2x23	27.94
2x24	29.21
2x25	30.48
2x26	31.75
2x27	33.02
2x28	34.29
2x29	35.56
2x30	36.83
2x31	38.10
2x32	39.37
2x33	40.64
2x34	41.91
2x35	43.18
2x36	44.45
2x37	45.72
2x38	46.99
2x39	48.26
2x40	49.53
2x40	50.80

APP.	ANGLES	±3°	SIZE
	LINEAR	0.0 ±0.38	A4
		0.00±0.25	NONE
			1/6

TITLE: 1.27x1.27mm Pin Header 21740 Series
 PART NO: 21X21740-XXXXXX-XXX-XXX-XXX
 DRW NO: DR. KEN
 UNIT: mm(INCH) PROJECT: 96.01.04



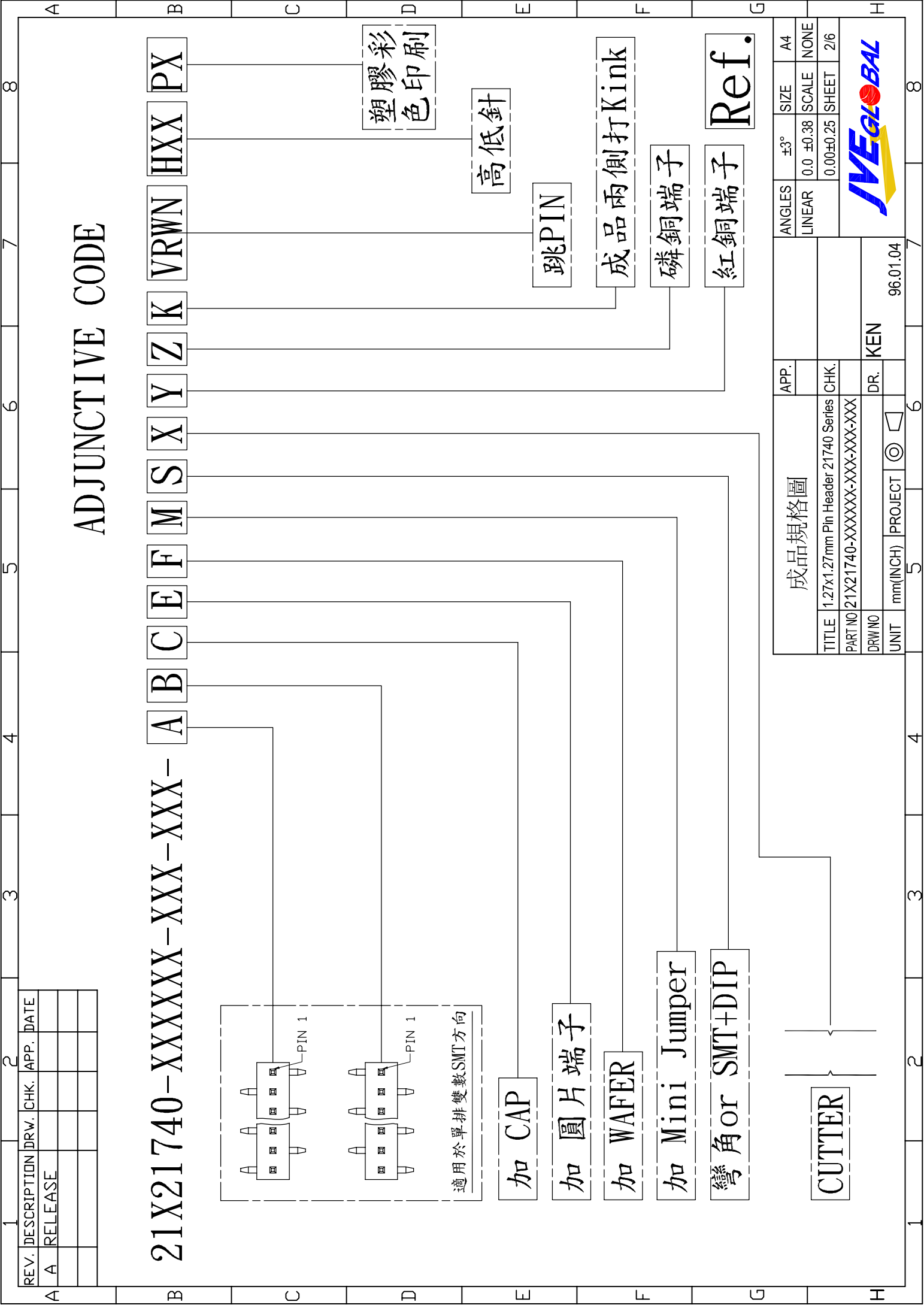

ADJUNCTIVE CODE

21X21740-XXXXXX-XXX-XXX-ABCDEFMSXYZKVRWNHXXPX

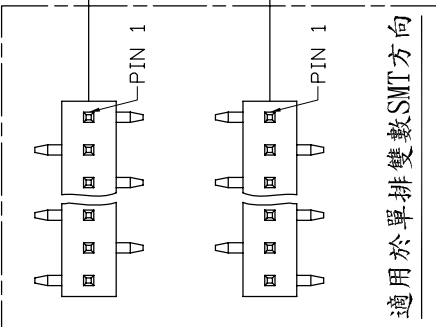

- 加 CAP
- 加圓片端子
- 加 WAFER
- 加 Mini Jumper
- 彎角 or SMT+DIP

CUTTER

塑膠彩色印刷

高低針

跳PIN

成品兩側打Kink

磷銅端子

紅銅端子

Ref.

成品規格圖

TITLE	1.27x1.27mm Pin Header 21740 Series	CHK.	
PART NO	21X21740-XXXXXX-XXX-XXX-XXX	DR.	KEN
UNIT	mm(INCH)	PROJECT	96.01.04

ANGLES	±3°	SIZE	A4
LINEAR	0.0 ±0.38	SCALE	NONE
	0.00±0.25	SHEET	2/6



1 2 3 4 5 6 7 8

E X T E R I O R

REV.	DESCRIPTION	DRW.	CHK.	APP.	DATE
A	RELEASE				

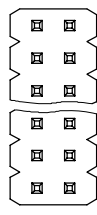

S10

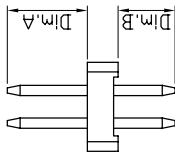

21X21740-XXS10X-XXX-A/B-C-XXX

Exterior — Dimension

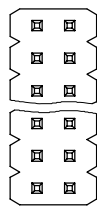

S20

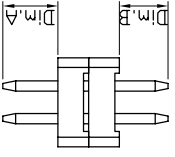

21X21740-XXS20X-XXX-A/B-XXX

Exterior — Dimension

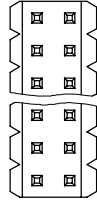

S21

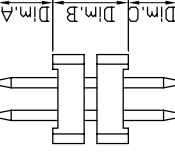

21X21740-XXS21X-XXX-A/B-C-XXX

Exterior — Dimension

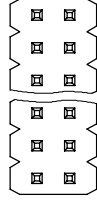

S22

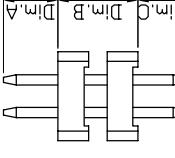

21X21740-XXS22X-XXX-A/B/C-XXX

Exterior — Dimension

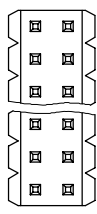

S23

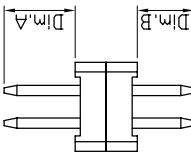

21X21740-XXS23X-XXX-A/B-XXX

Exterior — Dimension

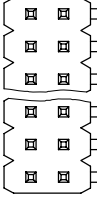

D00

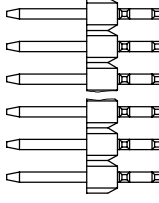

21X21740-XXD00X-XXX-A/B-XXX

Exterior — Dimension

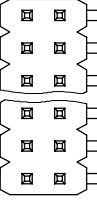

D10

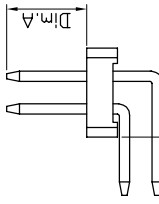

21X21740-XXD10X-XXX-A/B/C-XXX

Exterior — Dimension

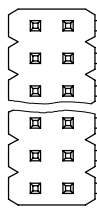

D20

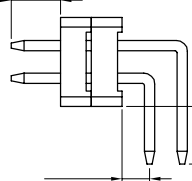

21X21740-XXD20X-XXX-A/B/C-XXX

Exterior — Dimension



J10

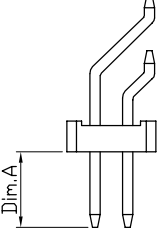

21X21740-XXJ10X-XXX-A-XXX

Exterior — Dimension

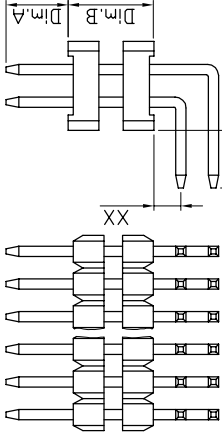

D21

21X21740-XXD21X-XXX-A/B/C-XXX

Exterior — Dimension

Ref.

成品規格圖		APP.	ANGLES	±3°	SIZE	A4
TITLE 1.27x1.27mm Pin Header 21740 Series		CHK.	LINEAR	0.0 ±0.38	SCALE	NONE
PART NO 21X21740-XXXXXX-XXX-XXX-XXX		DR.	0.00±0.25		SHEET	3/6
UNIT mm(INCH)		PROJECT	◎		96.01.04	
KEN						

A B C D E F G H

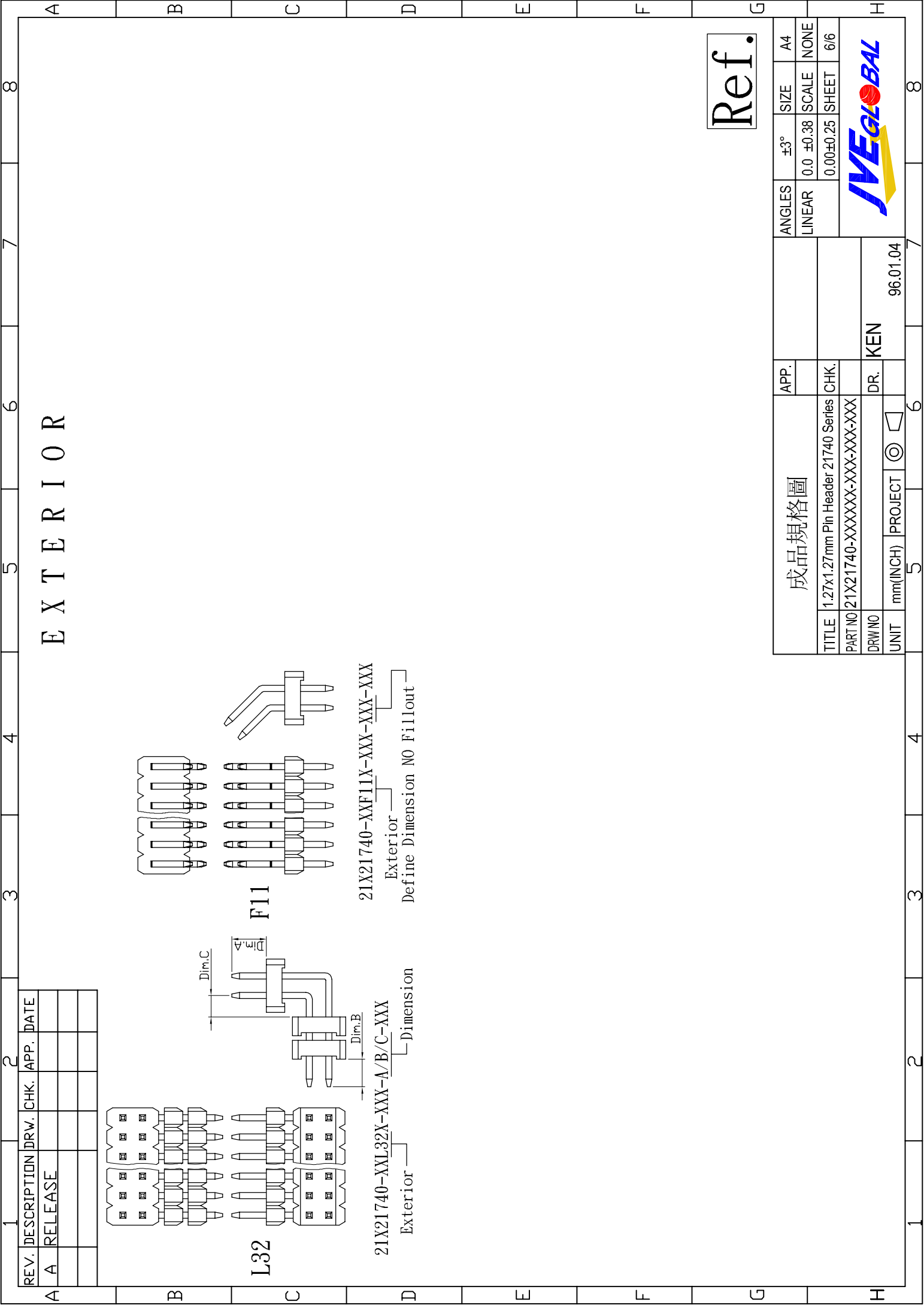

E X T E R I O R

REV.	DESCRIPTION	DRW.	CHK.	APP.	DATE
A	RELEASE				

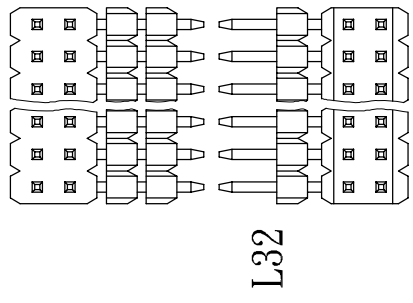

L32

21X21740-XXL32X-XXX-A/B/C-XXX

Exterior Dimension

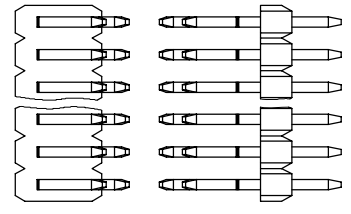

F11

21X21740-XXF11X-XXX-XXX-XXX

Exterior Define Dimension NO Fillout

Ref.

成品規格圖		APP.	ANGLES	±3°	SIZE	A4
TITLE	1.27x1.27mm Pin Header 21740 Series	CHK.	LINEAR	0.0 ±0.38	SCALE	NONE
PART NO	21X21740-XXXXXXXX-XXX-XXX-XXX			0.00±0.25	SHEET	6/6
DRW NO		DR.	KEN			
UNIT	mm(INCH)	PROJECT				

