

A B C D E F G H

1 2 3 4 5 6 7 8

REV.	DESCRIPTION	DRW.	CHK.	APP.	DATE
A	RELEASE				

ADJUNCTIVE CODE

21X21040-XXXXXX-XXX-XXX-**A B C E F M S X Y Z K VRWN HXX PX**

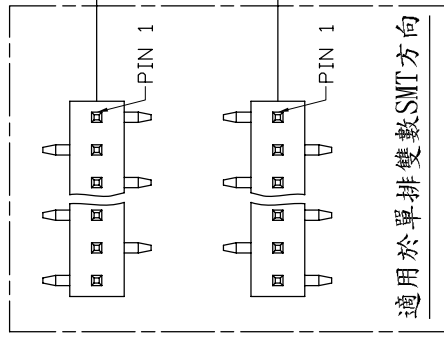

塑膠彩色印刷

高低針

跳PIN

成品兩側打Kink

磷銅端子

紅銅端子

加 CAP

加 圓片端子

加 WAFER

加 Mini Jumper

彎角 or SMT+DIP

CUTTER

Ref.

成品規格圖		APP.	ANGLES	±3°	SIZE	A4
TITLE	1.27x1.27mm Pin Header 21040 Series	CHK.	LINEAR	0.0 ±0.38	SCALE	NONE
PART NO	21X21040-XXXXXX-XXX-XXX-XXX			0.00±0.25	SHEET	2/5
DRW NO		DR.	KEN			
UNIT	mm(INCH)	PROJECT	◎ □			96.01.04



A B C D E F G H

1 2 3 4 5 6 7 8

REV.	DESCRIPTION	DRW.	CHK.	APP.	DATE
A	RELEASE				

E X T E R I O R

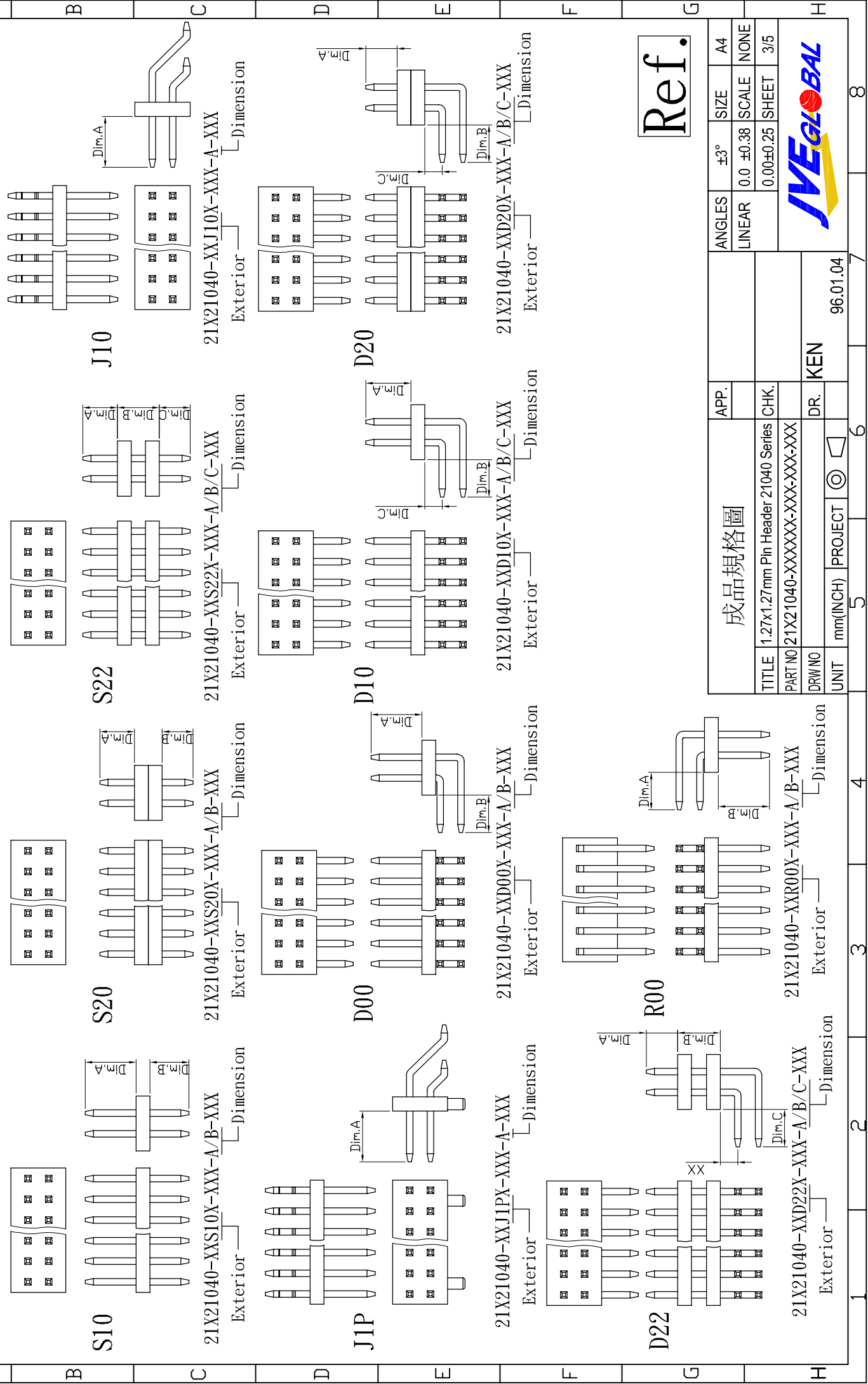

Ref.

成品規格圖		APP.	ANGLES	±3°	SIZE	A4
TITLE		1.27x1.27mm Pin Header 21040 Series	LINEAR	0.0	±0.38	NONE
PART NO		21X21040-XXXXXX-XXX-XXX-XXX				
DRW NO						
UNIT		mm(INCH)	PROJECT		KEN	
		5			96.01.04	



1 2 3 4 5 6 7 8

A B C D E F G H

1 2 3 4 5 6 7 8

REV.	DESCRIPTION	DRW.	CHK.	APP.	DATE
A	RELEASE				

EXTERIOR

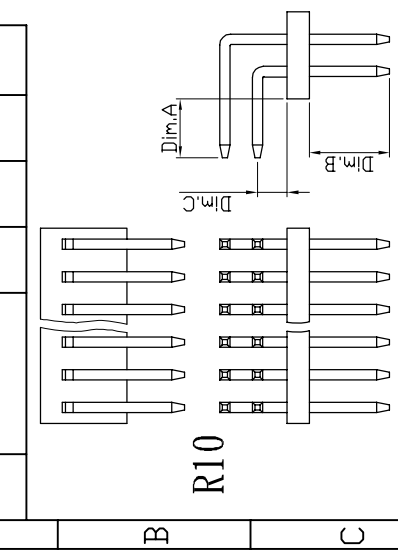

R10

21X21040-XXR10X-XXX-A/B/C-XXX

Exterior Dimension

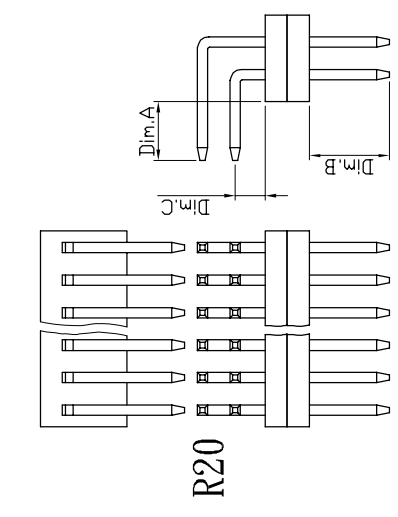

R20

21X21040-XXR20X-XXX-A/B/C-XXX

Exterior Dimension

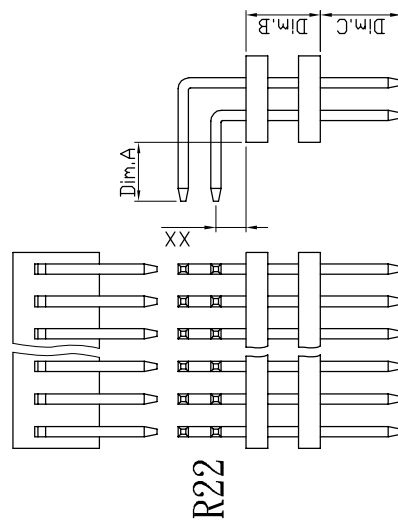

R22

21X21040-XXR22X-XXX-A/B/C-XXX

Exterior Dimension

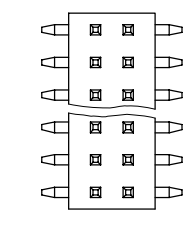

M00

21X21040-XXM00X-XXX-A-XXX

Exterior Dimension

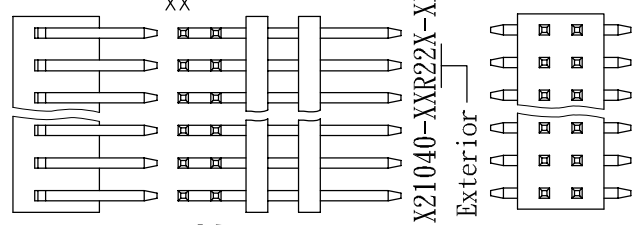

M20

21X21040-XXM20X-XXX-A/B-XXX

Exterior Dimension

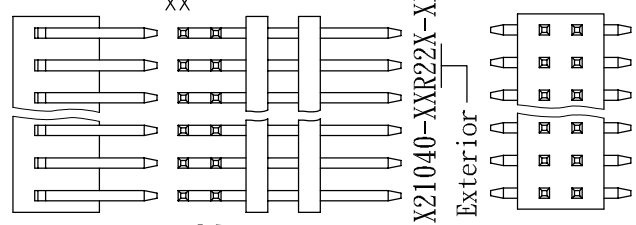

M22

21X21040-XXM22X-XXX-A/B/C-XXX

Exterior Dimension

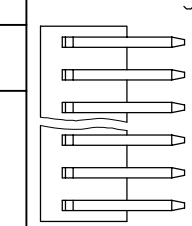

M10

21X21040-XXM10X-XXX-A/B-XXX

Exterior Dimension

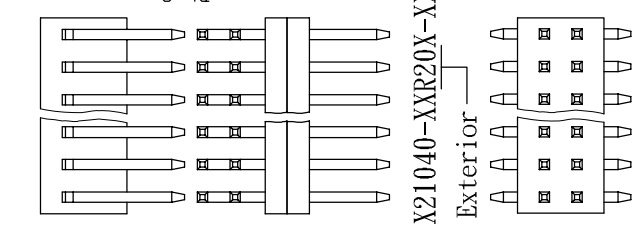

M20

21X21040-XXM20X-XXX-A/B-XXX

Exterior Dimension

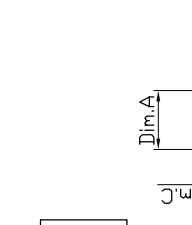

M10

21X21040-XXM10X-XXX-A/B-XXX

Exterior Dimension

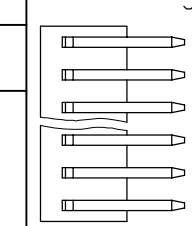

M2P

21X21040-XXM2PX-XXX-A/B-XXX

Exterior Dimension

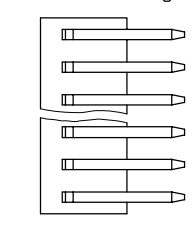

C00

21X21040-XXC00X-XXX-A/B-XXX

Exterior Dimension

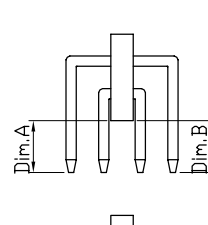
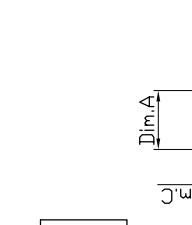

C00

21X21040-XXC00X-XXX-A/B-XXX

Exterior Dimension

Ref.

成品規格圖		APP.	ANGLES	±3°	SIZE	A4
TITLE 1.27x1.27mm Pin Header 21040 Series		CHK.	LINEAR	0.0 ±0.38	SCALE	NONE
PART NO 21X21040-XXXXXX-XXX-A/B/C-XXX				0.00±0.25	SHEET	4/5
DRW NO		DR.	JVEGLOBAL			
UNIT mm(INCH)		PROJECT	96.01.04			
5		6	7			
8		8				

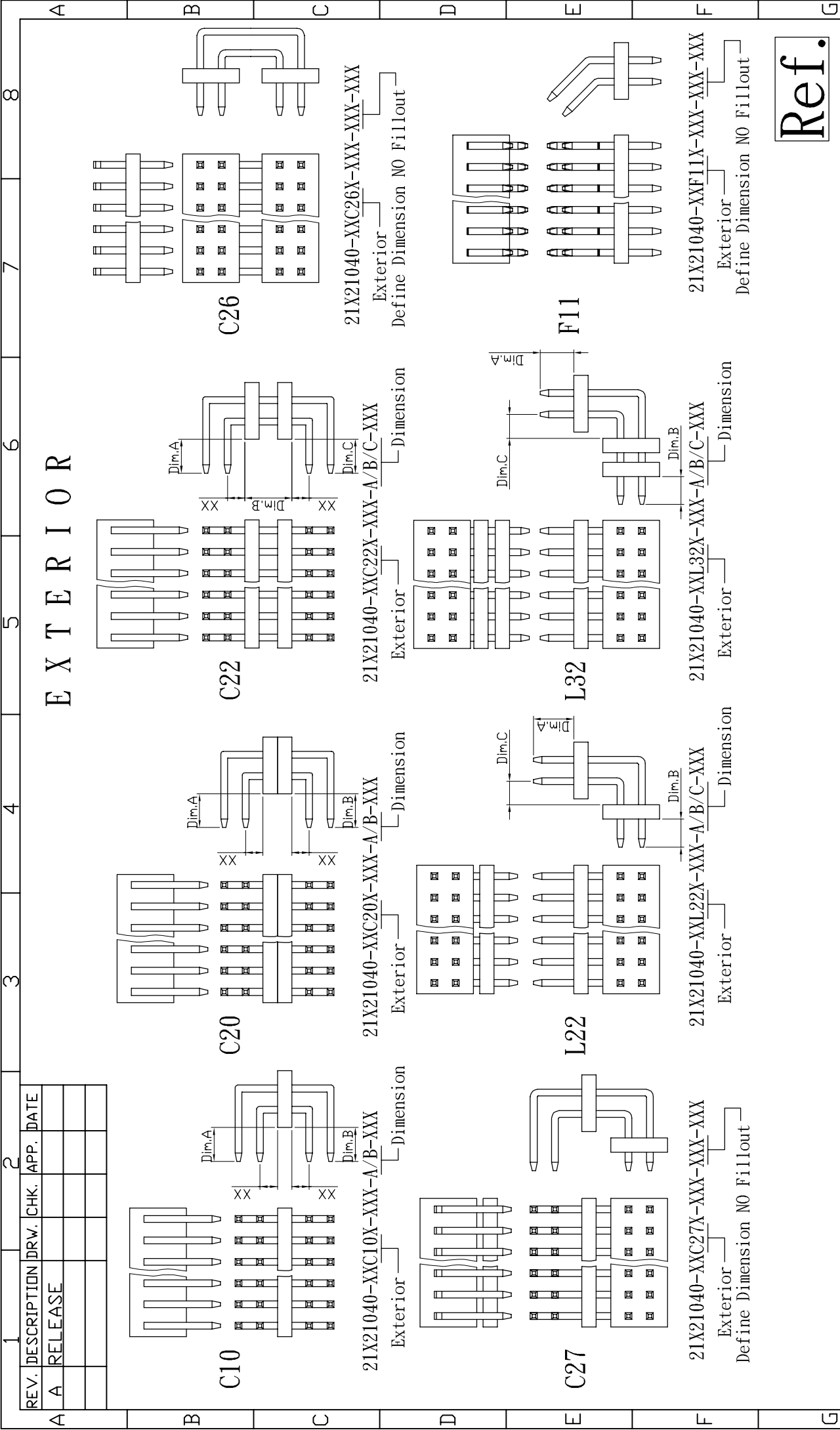

EXTERIOR

Ref.

REV.	DESCRIPTION	DRW.	CHK.	APP.	DATE
A	RELEASE				

成品規格圖		APP.	ANGLES	±3°	SIZE	A4
TITLE	1.27x1.27mm Pin Header 21040 Series	CHK.	LINEAR	0.0	±0.38	NONE
PART NO	21X21040-XXXXXX-XXX-XXX-XXX			0.00	±0.25	SHEET 5/5
DRW NO		DR.				
UNIT	mm(INCH)	PROJECT				

1 2 3 4 5 6 7 8

A B C D E F G H