

ORDERING INFORMATION

21X20840-XXXXXX-XXX-XXX-XXX

- Material: B PBT, N Nylon-6T, L LCP
- Row of plastic Double Row
- Plastic Height: 0.80mm
- Squite & Pitch: 0.40sq x PH1.27x1.27mm
- Number of Contact: 04-80
- Exterior: Referenced Sheet 3/5, 4/5, 5/5

- Adjunctive Code Referenced Sheet 2/5
- Dimension: 6, 6/3, 6/3/1.5
- Plating Type: A, A/B, A/B/C
- Gold Plated (G)
- Tin Plated (T)
- Duplex Plated (H)
- Contact Plating: 01 Normal, 03 3µ", 05 5µ", 10 10µ"
- Color: B Black, R Red, U Blue, ...

SPECIFICATIONS
 Current Rating: 1 Amp
 Insulator resistance: 1000 Megohms Min.
 Contact resistance: 20 m ohms Max.
 Dielectric withstanding: AC 500V/minute
 Operating Temperature: -40° ~ +105°C
 Contact Material: BRASS
 Insulator Material: High Temperature Thermoplastic +Glass Fibre UL94V-0
 Color: Black
 Finish: Gold, Tin or Duplex plated
 Standard: Gold flash all over
 Duplex plated:
 Gold plated on contact area
 Tin on solder area

RoHS Compliance

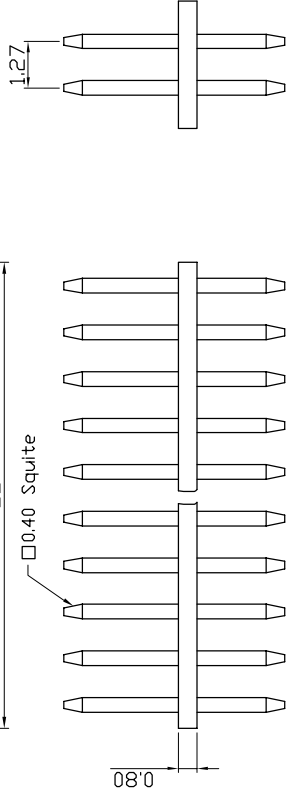
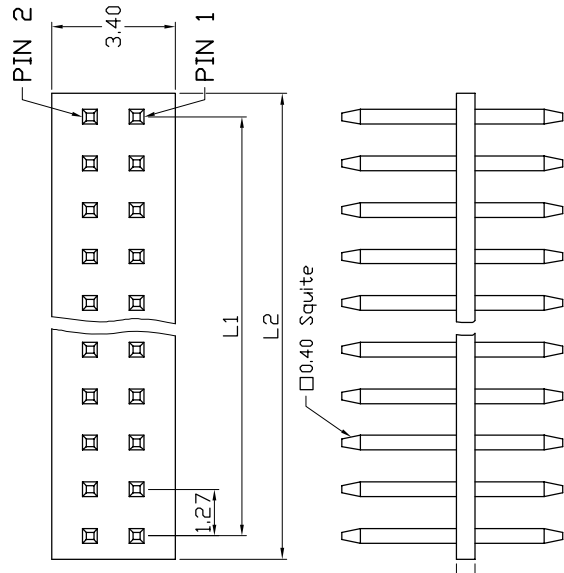

示意圖

Ref.

Circuits	Dimension mm	
	L1	L2
2x2	1.27	2.54
2x3	2.54	3.81
2x4	3.81	5.08
2x5	5.08	6.35
2x6	6.35	7.62
2x7	7.62	8.89
2x8	8.89	10.16
2x9	10.16	11.43
2x10	11.43	12.70
2x11	12.70	13.97
2x12	13.97	15.24
2x13	15.24	16.51
2x14	16.51	17.78
2x15	17.78	19.05
2x16	19.05	20.32
2x17	20.32	21.59
2x18	21.59	22.86
2x19	22.86	24.13
2x20	24.13	25.40
2x21	25.40	26.67
2x22	26.67	27.94
2x23	27.94	29.21
2x24	29.21	30.48
2x25	30.48	31.75
2x26	31.75	33.02
2x27	33.02	34.29
2x28	34.29	35.56
2x29	35.56	36.83
2x30	36.83	38.10
2x31	38.10	39.37
2x32	39.37	40.64
2x33	40.64	41.91
2x34	41.91	43.18
2x35	43.18	44.45
2x36	44.45	45.72
2x37	45.72	46.99
2x38	46.99	48.26
2x39	48.26	49.53
2x40	49.53	50.80

APP.		ANGLES	±3°	SIZE	A4
成品規格圖		LINEAR	0.0 ±0.38	SCALE	NONE
TITLE	1.27x1.27mm Pin Header 20840 Series	CHK.		SHEET	1/5
PART NO	21X20840-XXXXXX-XXX-XXX-XXX	DR.	KEN		
UNIT	mm(INCH)	PROJECT			
			96.01.04		



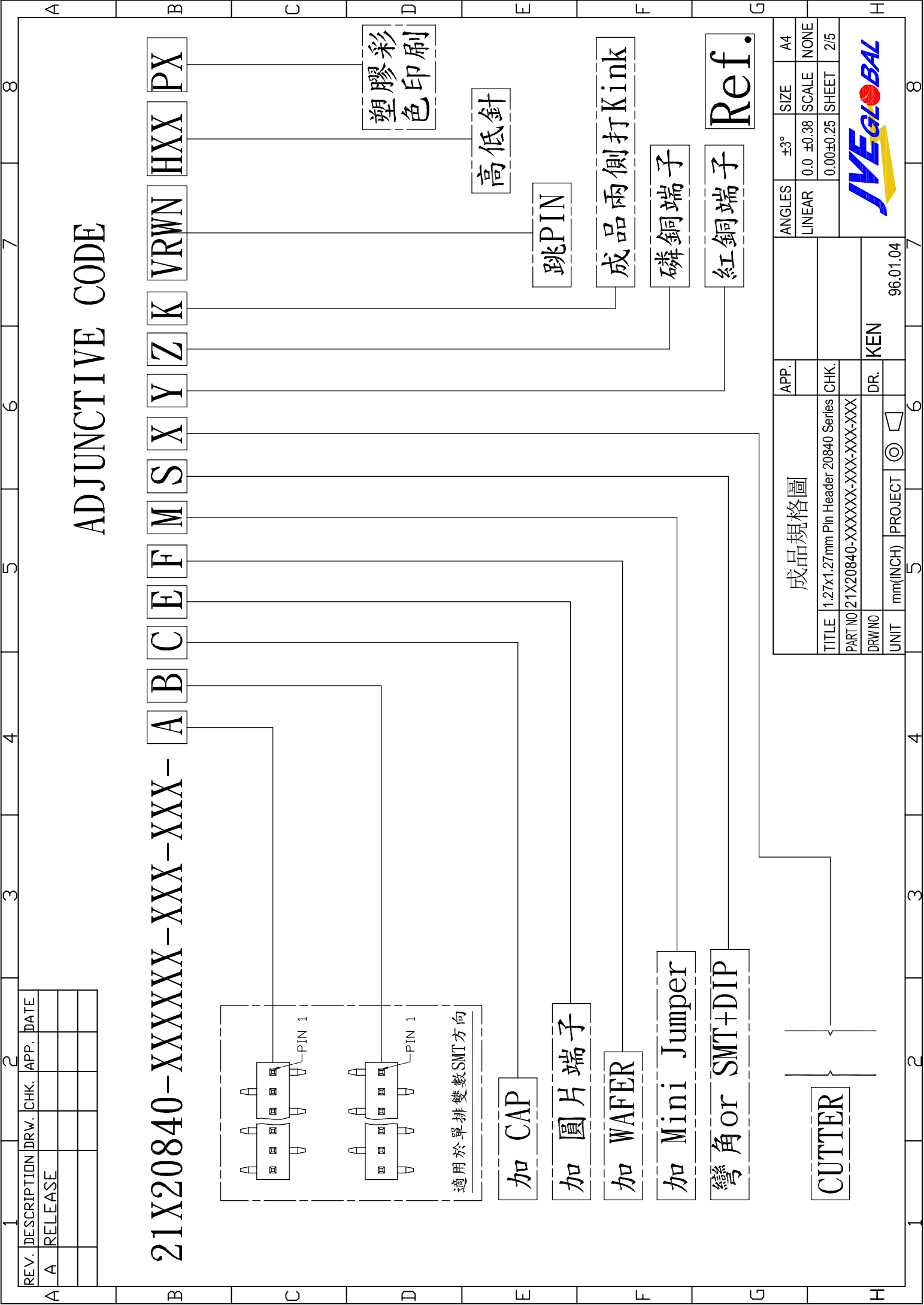

ADJUNCTIVE CODE

21X20840-XXXXXX-XXX-XXX-ABCDEFMSXYZKVRWNHXXPX

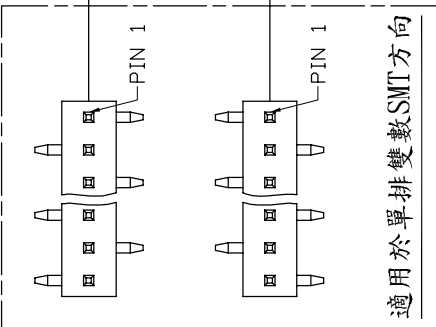

- 加 CAP
- 加圓片端子
- 加 WAFER
- 加 Mini Jumper
- 彎角 or SMT+DIP

塑膠彩色印刷

高低針

跳PIN

成品兩側打Kink

磷銅端子

紅銅端子

Ref.

REV.	DESCRIPTION	DRW.	CHK.	APP.	DATE
A	RELEASE				

成品規格圖		APP.	ANGLES	±3°	SIZE	A4
TITLE	1.27x1.27mm Pin Header 20840 Series	CHK.	LINEAR	0.0 ±0.38	SCALE	NONE
PART NO	21X20840-XXXXXX-XXX-XXX-XXX			0.00±0.25	SHEET	2/5
DRW NO		DR.	KEN			
UNIT	mm(INCH)	PROJECT	◎			
				96.01.04		



EXTERIOR

REV.	DESCRIPTION	DRW.	CHK.	APP.	DATE
A	RELEASE				

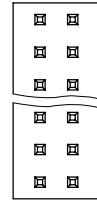

S10

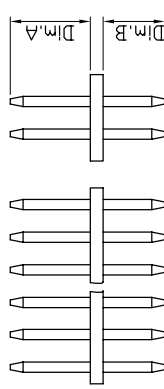

21X20840-XXS10X-XXX-A/B-XXX

Exterior Dimension

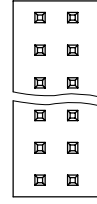

S20

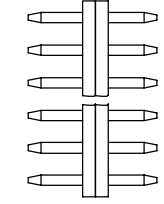

21X20840-XXS20X-XXX-A/B-XXX

Exterior Dimension

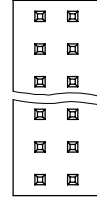

S22

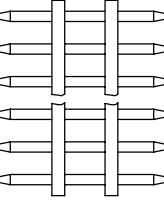

21X20840-XXS22X-XXX-A/B/C-XXX

Exterior Dimension

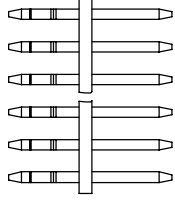

J10

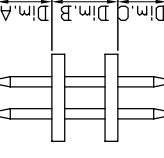

21X20840-XXJ10X-XXX-A-XXX

Exterior Dimension

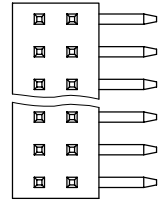

D00

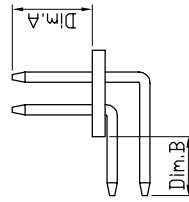

21X20840-XXD00X-XXX-A/B-XXX

Exterior Dimension

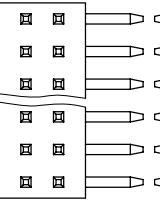

D10

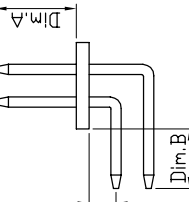

21X20840-XXD10X-XXX-A/B/C-XXX

Exterior Dimension

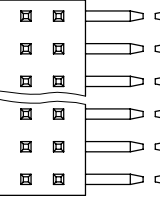

D20

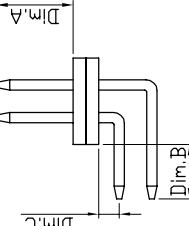

21X20840-XXD20X-XXX-A/B/C-XXX

Exterior Dimension

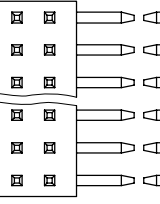

D22

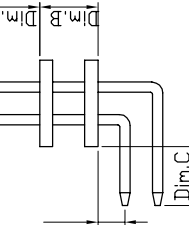

21X20840-XXD22X-XXX-A/B/C-XXX

Exterior Dimension

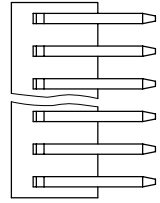

R00

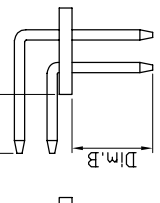

21X20840-XXR00X-XXX-A/B-XXX

Exterior Dimension

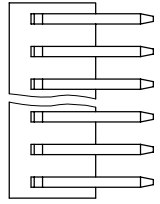

R10

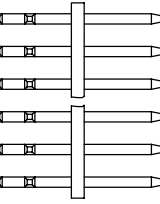

21X20840-XXR10X-XXX-A/B/C-XXX

Exterior Dimension

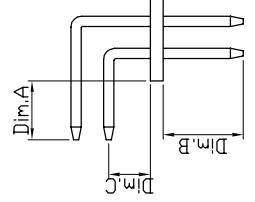

R10

21X20840-XXR10X-XXX-A/B/C-XXX

Exterior Dimension

Ref.

成品規格圖		APP.	ANGLES	±3°	SIZE	A4
TITLE		1.27x1.27mm Pin Header 20840 Series	LINEAR	0.0	±0.38	NONE
PART NO		21X20840-XXXXXX-XXX-XXX-XXX	CHK.		0.00±0.25	3/5
DRW NO			DR.		KEN	
UNIT		mm(INCH)	PROJECT		96.01.04	



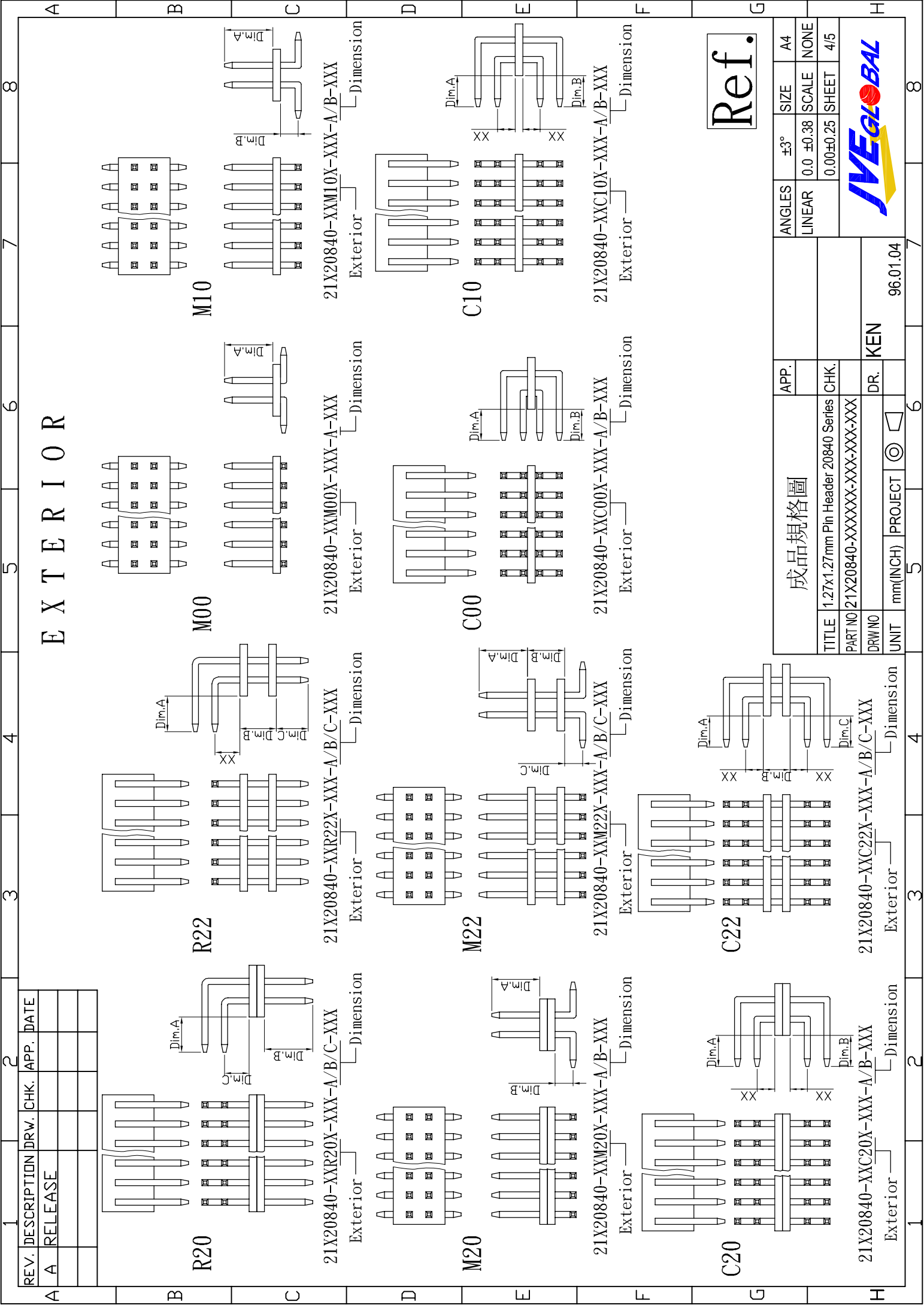

E X T E R I O R

REV.	DESCRIPTION	DRW.	CHK.	APP.	DATE
A	RELEASE				

Ref.

成品規格圖		APP.	ANGLES	±3°	SIZE	A4
TITLE 1.27x1.27mm Pin Header 20840 Series		CHK.	LINEAR	0.0 ±0.38	SCALE	NONE
PART NO 21X20840-XXXXXX-A/B/C-XXX		DR.		0.00±0.25	SHEET	4/5
UNIT mm(INCH)		PROJECT	◎		KEN	
96.01.04						



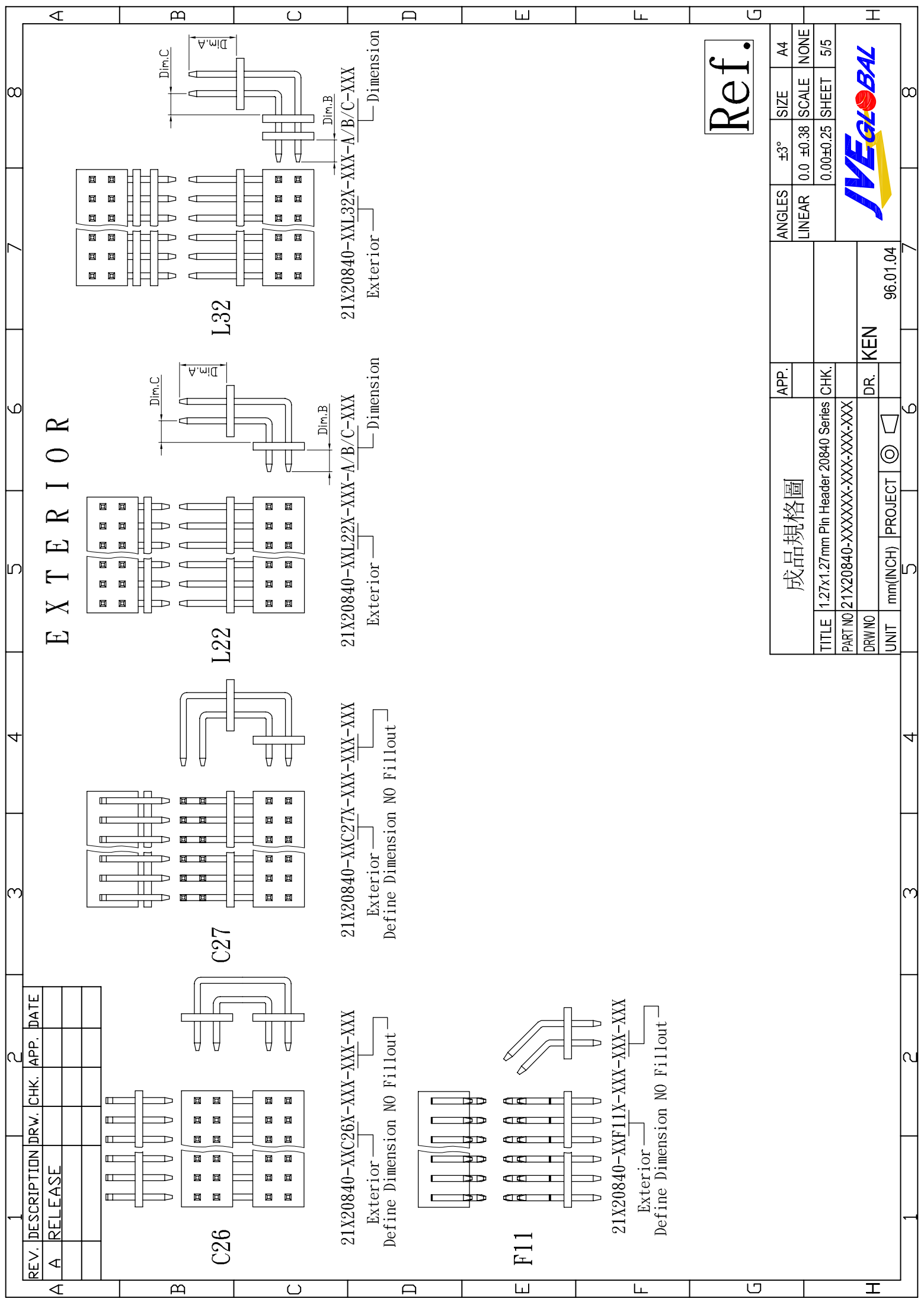

EXTERIOR

REV.	DESCRIPTION	DRW.	CHK.	APP.	DATE
A	RELEASE				

Ref.

成品規格圖		APP.	ANGLES	±3°	SIZE	A4
TITLE	1.27x1.27mm Pin Header 20840 Series	CHK.	LINEAR	0.0 ±0.38	SCALE	NONE
PART NO	21X20840-XXXXXXXX-XXX-XXX-XXX			0.00±0.25	SHEET	5/5
DRW NO		DR.	KEN			
UNIT	mm(INCH)	PROJECT	96.01.04			

