

REV.	DESCRIPTION	DRW.	CHK.	APP.	DATE
A	RELEASE				

SPECIFICATIONS

Current Rating:
 1 Amp
 Insulator resistance:
 1000 Megohms Min.
 Contact resistance:
 20 m ohms Max.
 Dielectric withstanding:
 AC 500V/minute
 Operating Temperature:
 -40° ~ +105°C
 Contact Material:
 BRASS
 Insulator Material:
 High Temperature Thermoplastic
 +Glass Fibre UL94V-0
 Color: Black
 Finish:
 Gold, Tin or Duplex plated
 Standard: Gold flash all over
 Duplex plated:
 Gold plated on contact area
 Tin on solder area

RoHS Compliance

ORDERING INFORMATION

21X11040-XXXXXX-XXX-XXX-XXX

Material: B PBT, N Nylon-6T, L LCP
 Row of plastic Single Row
 Plastic Height: 1.00mm
 Spacing & Pitch: 0.40sq x PH1.27mm
 Number of Contact: 02-40
 Exterior: Referenced Sheet 3/6, 4/6, 5/6, 6/6
 Adjunctive Code Referenced Sheet 2/6
 Dimension: 6, 6/3, A/B, 6/3/1.5, A/B/C
 Plating Type: G Gold Plated, T Tin Plated, H Duplex Plated
 Contact Plating: 01 Normal, 03 3µ", 05 5µ", 10 10µ"
 Color: B Black, R Red, U Blue, ...

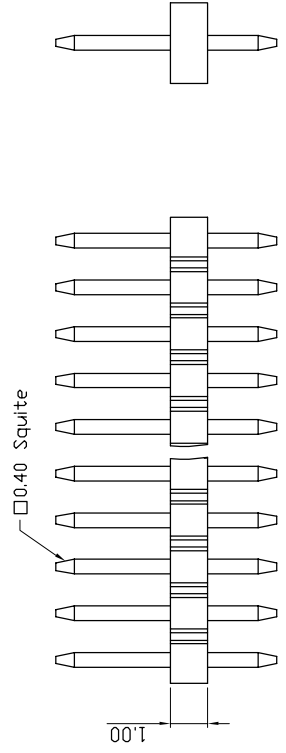
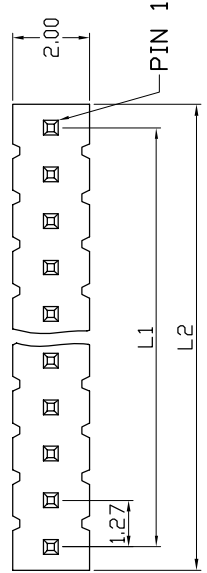

示意圖

Ref.

Circuits	Dimension mm
2	L1
3	L2
4	1.27
5	2.54
6	3.81
7	5.08
8	6.35
9	7.62
10	8.89
11	10.16
12	11.43
13	12.70
14	13.97
15	15.24
16	16.51
17	17.78
18	19.05
19	20.32
20	21.59
21	22.86
22	24.13
23	25.40
24	26.67
25	27.94
26	29.21
27	30.48
28	31.75
29	33.02
30	34.29
31	35.56
32	36.83
33	38.10
34	39.37
35	40.64
36	41.91
37	43.18
38	44.45
39	45.72
40	46.99
	48.26
	49.53
	50.80

APP.	ANGLES	±3°	SIZE	A4
成品規格圖	LINEAR	0.0	±0.38	NONE
TITLE: 1.27mm Pin Header 11040 Series	CHK.	0.00	±0.25	1/6
PART NO: 21X11040-XXXXXX-XXX-XXX-XXX	DR.			
DRW NO	KEN			
UNIT: mm(INCH)	PROJECT	96.01.04		

A B C D E F G H

1 2 3 4 5 6 7 8

REV.	DESCRIPTION	DRW.	CHK.	APP.	DATE
A	RELEASE				

ADJUNCTIVE CODE

21X11040-XXXXXX-XXX-XXX-**A B C E F M S X Y Z K VRWN HXX PX**

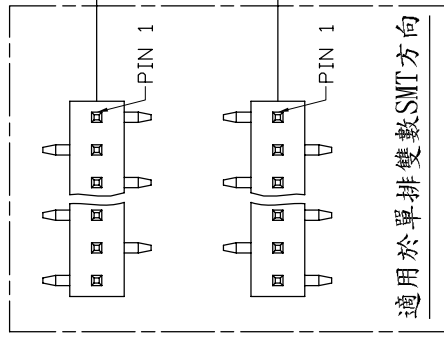

塑膠彩色印刷

高低針

跳PIN

成品兩側打Kink

磷銅端子

紅銅端子

加 CAP

加 圓片端子

加 WAFER

加 Mini Jumper

彎角 or SMT+DIP

CUTTER

Ref.

成品規格圖		APP.	ANGLES	±3°	SIZE	A4
TITLE	1.27mm Pin Header 11040 Series	CHK.	LINEAR	0.0 ±0.38	SCALE	NONE
PART NO	21X11040-XXXXXX-XXX-XXX-XXX			0.00±0.25	SHEET	2/6
DRW NO		DR.	KEN			
UNIT	mm(INCH)	PROJECT	96.01.04			



A B C D E F G H

1 2 3 4 5 6 7 8

1 2 3 4 5 6 7 8

E X T E R I O R

REV.	DESCRIPTION	DRW.	CHK.	APP.	DATE
A	RELEASE				

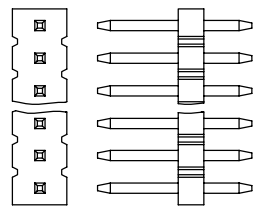

S10

21X11040-XXS10X-XXX-A/B-XXX
Exterior ——— Dimension

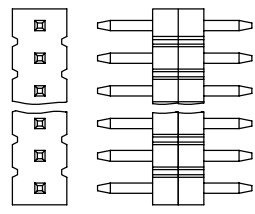

S20

21X11040-XXS20X-XXX-A/B-XXX
Exterior ——— Dimension

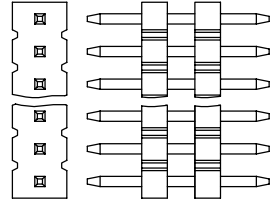

S22

21X11040-XXS22X-XXX-A/B/C-XXX
Exterior ——— Dimension

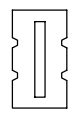

A10

21X11040-XXA10X-XXX-A/B-XXX
Exterior ——— Dimension

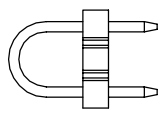

J10

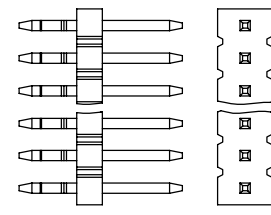

21X11040-XXJ10X-XXX-A-XXX
Exterior ——— Dimension

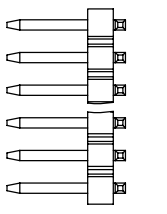

D00

21X11040-XXD00X-XXX-A/B-XXX
Exterior ——— Dimension

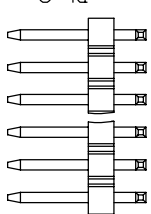

D10

21X11040-XXD10X-XXX-A/B/C-XXX
Exterior ——— Dimension

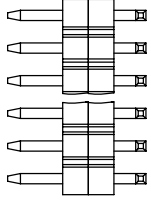

D20

21X11040-XXD20X-XXX-A/B/C-XXX
Exterior ——— Dimension

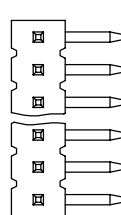

D22

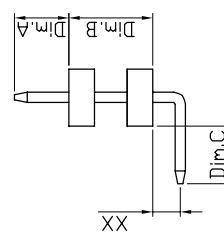

21X11040-XXD22X-XXX-A/B/C-XXX
Exterior ——— Dimension

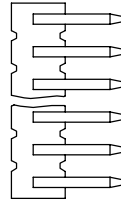

R00

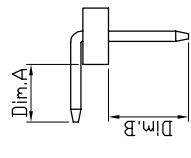

21X11040-XXR00X-XXX-A/B-XXX
Exterior ——— Dimension

Ref.

成品規格圖		APP.	ANGLES	±3°	SIZE	A4
TITLE 1.27mm Pin Header 11040 Series		CHK.	LINEAR	0.0 ±0.38	SCALE	NONE
PART NO 21X11040-XXXXXX-XXX-XXX-XXX		DR.				
DRW NO		DR.				
UNIT mm(INCH)		PROJECT				
96.01.04						



A B C D E F G H

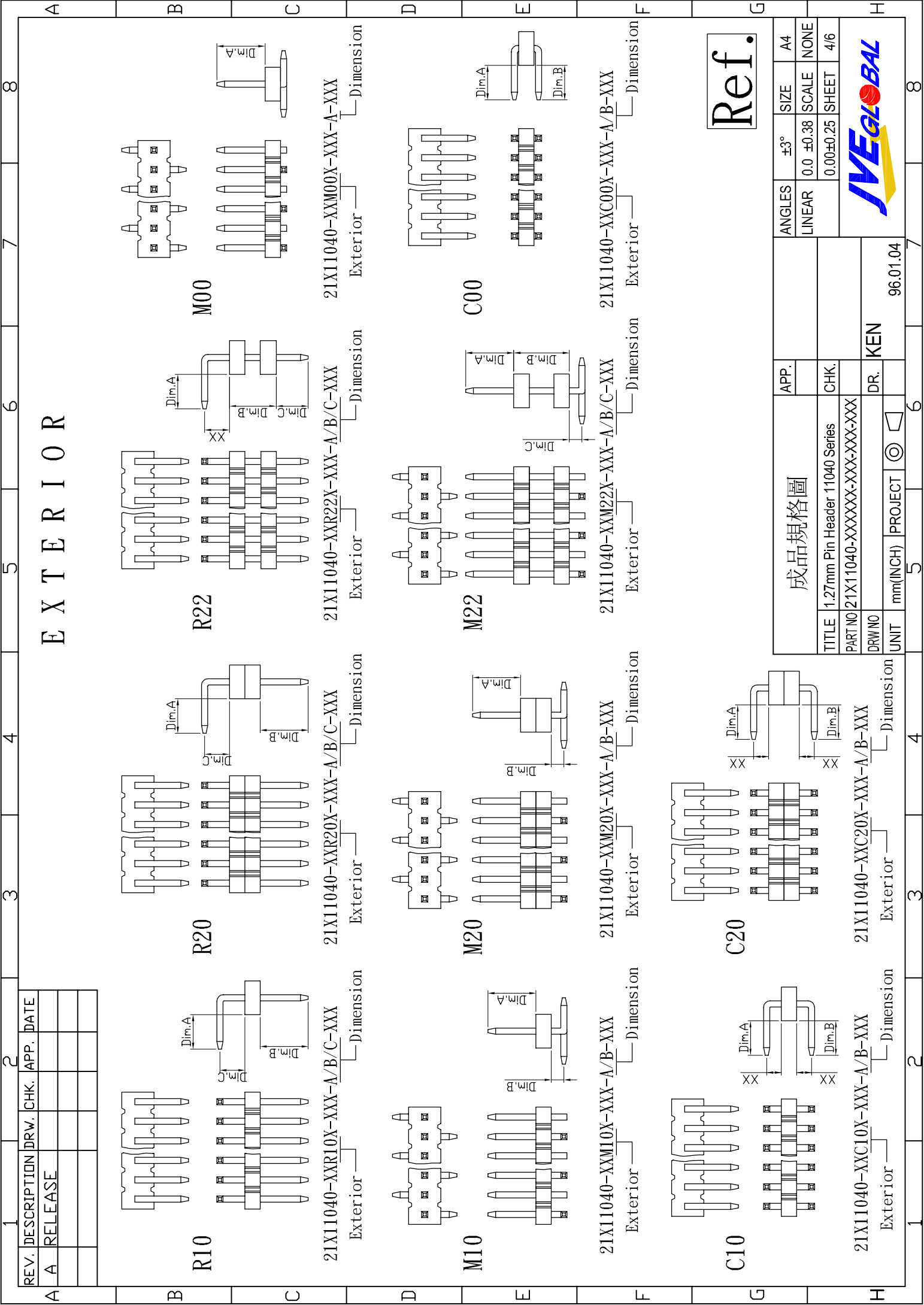

REV.	DESCRIPTION	DRW.	CHK.	APP.	DATE
A	RELEASE				

Ref.

成品規格圖		APP.	ANGLES	±3°	SIZE	A4
TITLE	1.27mm Pin Header 11040 Series		LINEAR	0.0 ±0.38	SCALE	NONE
PART NO	21X11040-XXXXXX-XXX-XXX-XXX	CHK.		0.00±0.25	SHEET	4/6
DRW NO		DR.	KEN			
UNIT	mm(INCH)	PROJECT	96.01.04			



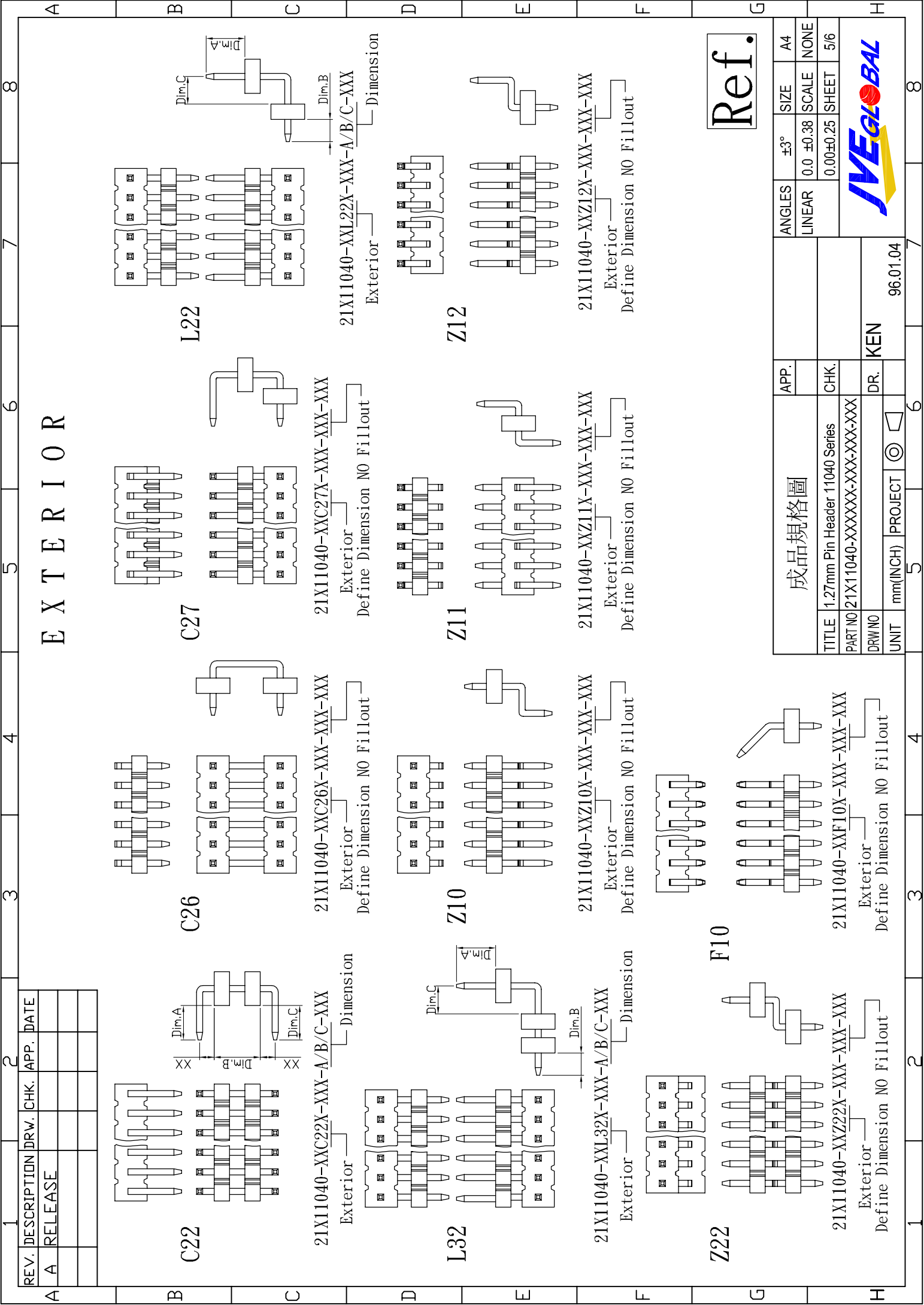

E X T E R I O R

REV.	DESCRIPTION	DRW.	CHK.	APP.	DATE
A	RELEASE				

Ref.

成品規格圖		APP.	ANGLES	±3°	SIZE	A4
TITLE	1.27mm Pin Header 11040 Series	CHK.	LINEAR	0.0 ±0.38	SCALE	NONE
PART NO	21X11040-XXXXXX-XXX-XXX-XXX	DR.		0.00±0.25	SHEET	5/6
DRW NO						
UNIT	mm(INCH)	PROJECT	◎			
	5					
		KEN				
		96.01.04				



