

REV.	DESCRIPTION	DRW.	CHK.	APP.	DATE
A	RELEASE				

SPECIFICATIONS

- Current Rating: 1 Amp
- Insulator resistance: 1000 Megohms Min.
- Contact resistance: 20 m ohms Max.
- Dielectric withstanding: AC 500V/minute
- Operating Temperature: -40° ~ +105°C
- Contact Material: BRASS
- Insulator Material: High Temperature Thermoplastic
- +Glass Fibre UL94V-0
- Color: Black
- Finish: Gold, Tin or Duplex plated
- Standard: Gold flash all over
- Duplex plated:
- Gold plated on contact area
- Tin on solder area

RoHS Compliance

ORDERING INFORMATION

21X2154B-XXXXXX-XXX-XXX-XXX

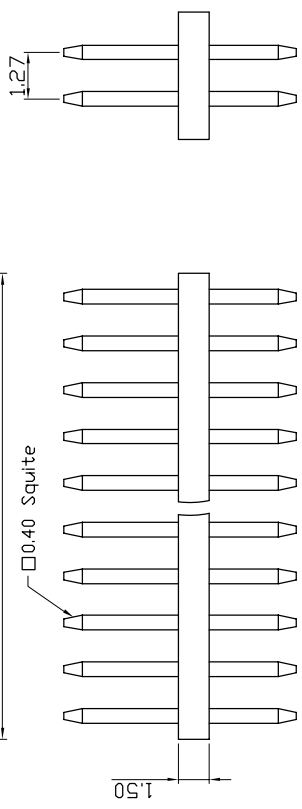
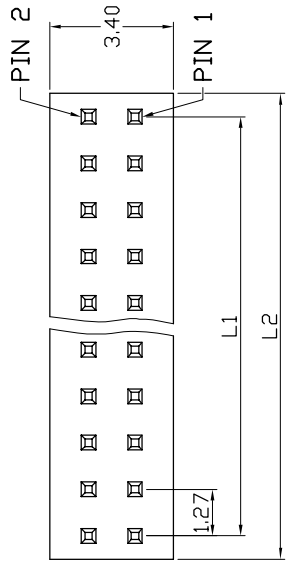
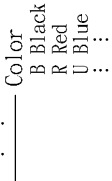
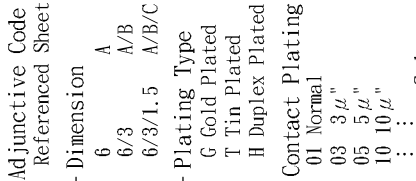
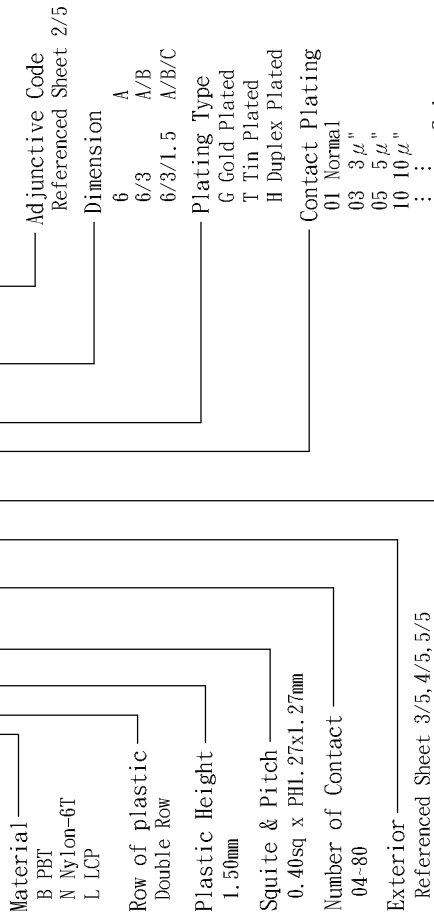

示意图

Ref.

Circuits	Dimension mm
L1	L2
2x2	1.27
2x3	2.54
2x4	3.81
2x5	5.08
2x6	6.35
2x7	7.62
2x8	8.89
2x9	10.16
2x10	11.43
2x11	12.70
2x12	13.97
2x13	15.24
2x14	16.51
2x15	17.78
2x16	19.05
2x17	20.32
2x18	21.59
2x19	22.86
2x20	24.13
2x21	25.40
2x22	26.67
2x23	27.94
2x24	29.21
2x25	30.48
2x26	31.75
2x27	33.02
2x28	34.29
2x29	35.56
2x30	36.83
2x31	38.10
2x32	39.37
2x33	40.64
2x34	41.91
2x35	43.18
2x36	44.45
2x37	45.72
2x38	46.99
2x39	48.26
2x40	49.53
	50.80

APP.	SIZE	SCALE	SHEET
	A4	NONE	1/5
成品规格图			
TITLE 1.27x1.27mm Pin Header 2154B Series			
PART NO 21X2154B-XXXXXX-XXX-XXX-XXX			
DRW NO			
UNIT mm(INCH) PROJECT KEN			
96.01.04			



A B C D E F G H

1 2 3 4 5 6 7 8

REV.	DESCRIPTION	DRW.	CHK.	APP.	DATE
A	RELEASE				

ADJUNCTIVE CODE

21X2154B-XXXXXX-XXX-XXX- A B C E F M S X Y Z K VRWN HXX PX

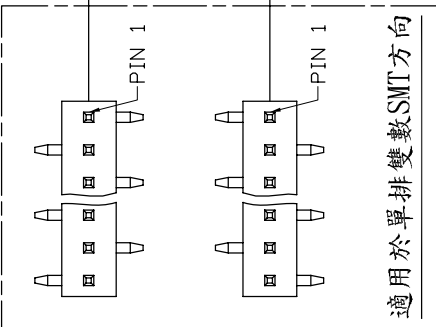

加 CAP

加 圓片 端子

加 WAFER

加 Mini Jumper

彎角 or SMT+DIP

CUTTER

塑膠彩色印刷

高低針

跳PIN

成品兩側打Kink

磷銅端子

紅銅端子

Ref.

成品規格圖

TITLE		APP.	ANGLES	±3°	SIZE	A4
1.27x1.27mm Pin Header 2154B Series		CHK.	LINEAR	0.0 ±0.38	SCALE	NONE
PART NO 21X2154B-XXXXXX-XXX-XXX-XXX				0.00±0.25	SHEET	2/5
DRW NO		DR.	KEN			
UNIT mm(INCH)		PROJECT	96.01.04			



A B C D E F G H

1 2 3 4 5 6 7 8

REV.	DESCRIPTION	DRW.	CHK.	APP.	DATE
A	RELEASE				

E X T E R I O R

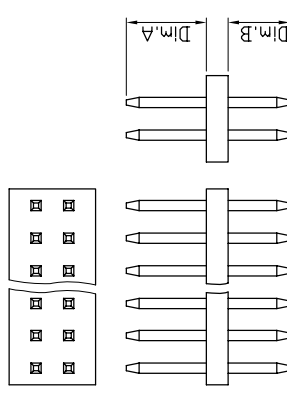
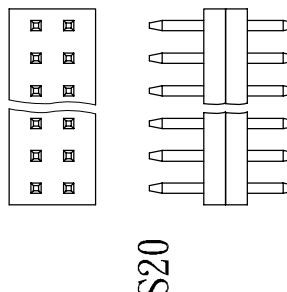
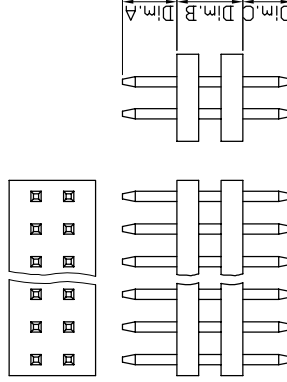
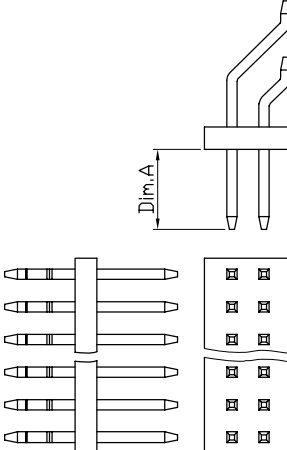
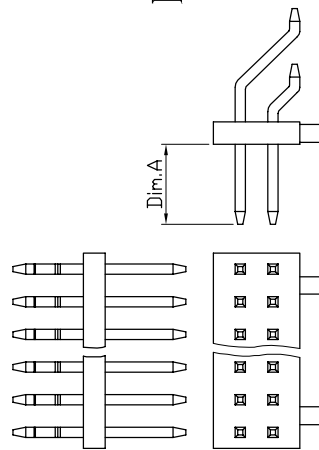
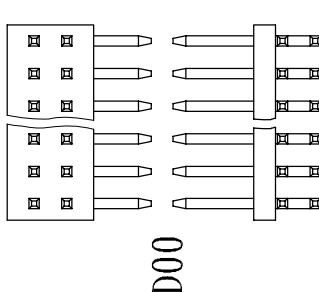
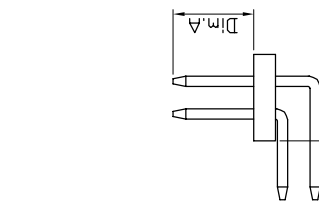
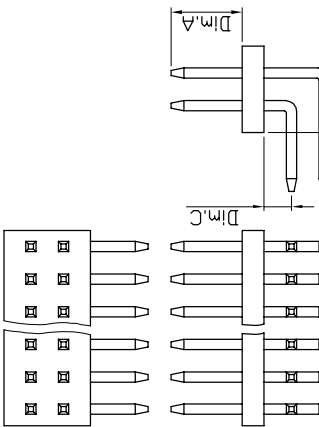
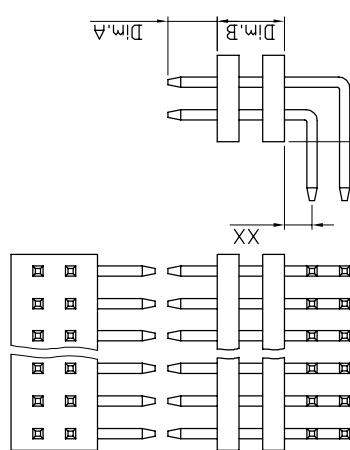
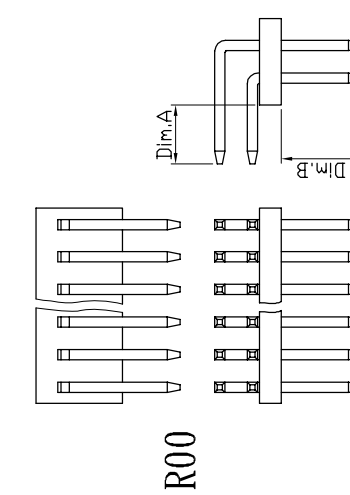
1	2	3	4	5	6	7	8	
A	E X T E R I O R						H	
B	S10  21X2154B-XXS10X-XXX-A/B-XXX Exterior Dimension	S20  21X2154B-XXS20X-XXX-A/B-XXX Exterior Dimension	S22  21X2154B-XXS22X-XXX-A/B/C-XXX Exterior Dimension	J10  21X2154B-XXJ10X-XXX-A-XXX Exterior Dimension	J11P  21X2154B-XXJ1PX-XXX-A-XXX Exterior Dimension	D00  21X2154B-XXD00X-XXX-A/B-XXX Exterior Dimension	D10  21X2154B-XXD10X-XXX-A/B/C-XXX Exterior Dimension	D20  21X2154B-XXD20X-XXX-A/B/C-XXX Exterior Dimension
F	D22  21X2154B-XXD22X-XXX-A/B/C-XXX Exterior Dimension	R00  21X2154B-XXR00X-XXX-A/B-XXX Exterior Dimension	Ref.					7
G	成品規格圖						8	
		TITLE		APP.		ANGLES		
		1.27x1.27mm Pin Header 2154B Series		1.27x1.27mm Pin Header 2154B Series		LINEAR		
		PART NO 21X2154B-XXXXXX-XXX-XXX-XXX		CHK.		SCALE NONE		
		DRW NO		DR.		SHEET 3/5		
		UNIT mm(INCH)		PROJECT		KEN		
				96.01.04				



EXTERIOR

REV.	DESCRIPTION	DRW.	CHK.	APP.	DATE
A	RELEASE				

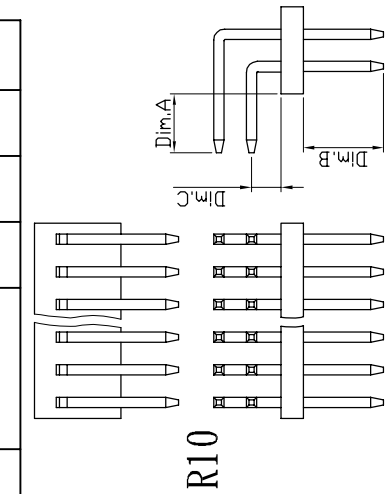

R10

21X2154B-XXR10X-XXX-A/B/C-XXX

Exterior — Dimension

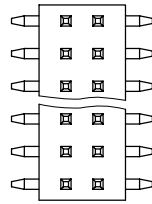

M0P

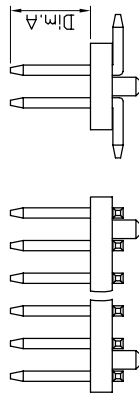

M2P

21X2154B-XXM0PX-XXX-A-XXX

Exterior — Dimension

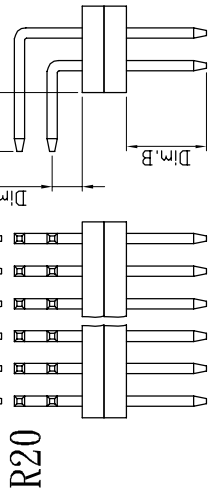
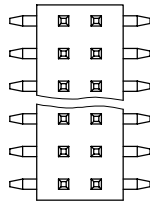

R20

21X2154B-XXR20X-XXX-A/B/C-XXX

Exterior — Dimension

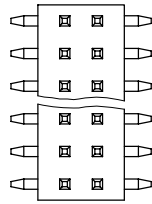

M10

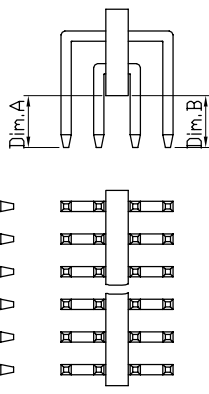
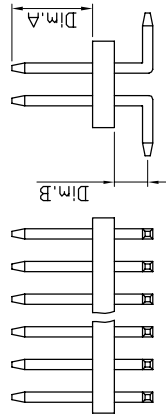

C00

21X2154B-XXM10X-XXX-A/B-XXX

Exterior — Dimension

21X2154B-XXC00X-XXX-A/B-XXX

Exterior — Dimension

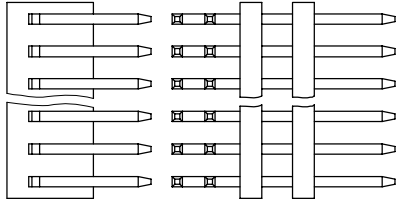

R22

21X2154B-XXR22X-XXX-A/B/C-XXX

Exterior — Dimension

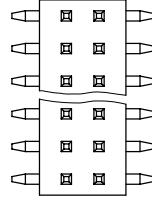

M20

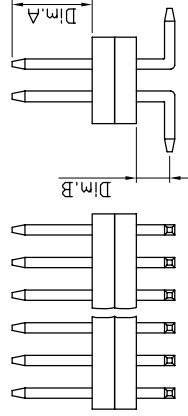

21X2154B-XXM20X-XXX-A/B-XXX

Exterior — Dimension

21X2154B-XXM22X-XXX-A/B/C-XXX

Exterior — Dimension

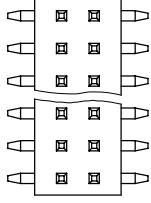

M00

21X2154B-XXM00X-XXX-A-XXX

Exterior — Dimension

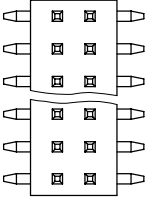

M22

Ref.

成品規格圖		APP.	ANGLES	±3°	SIZE	A4
TITLE	1.27x1.27mm Pin Header 2154B Series	CHK.	LINEAR	0.0	±0.38	NONE
PART NO	21X2154B-XXXXXX-XXX-XXX-XXX			0.00±0.25		4/5
DRW NO		DR.	KEN			
UNIT	mm(INCH)	PROJECT	◎			



96.01.04

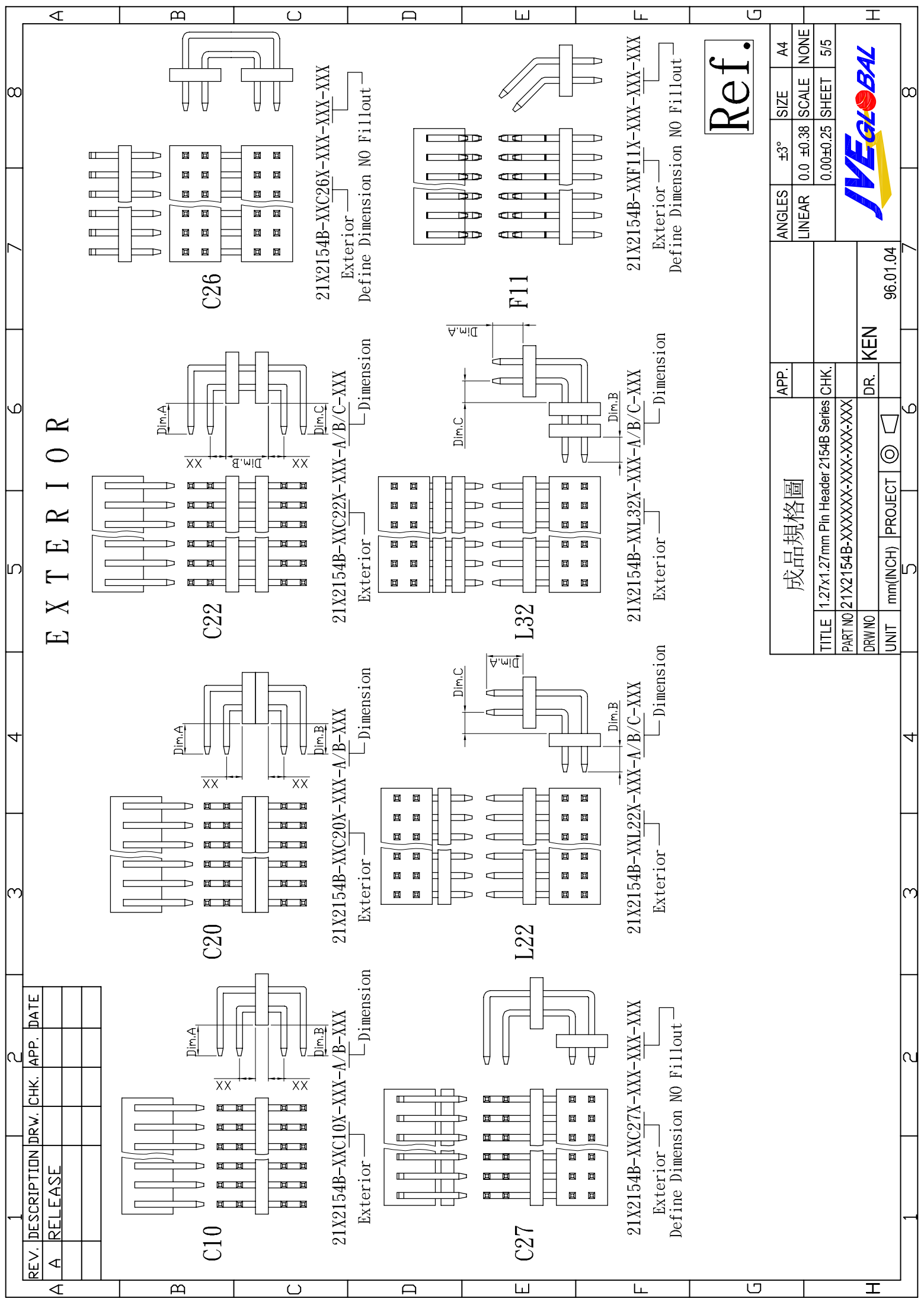

EXTERIOR

REV.	DESCRIPTION	DRW.	CHK.	APP.	DATE
A	RELEASE				

Ref.

成品規格圖		APP.	ANGLES	±3°	SIZE	A4
TITLE	1.27x1.27mm Pin Header 2154B Series	CHK.	LINEAR	0.0	±0.38	NONE
PART NO	21X2154B-XXXXXX-XXX-XXX-XXX			0.00	±0.25	SHEET 5/5
DRW NO		DR.	KEN			
UNIT	mm(INCH)	PROJECT	◎			
	5					
		96.01.04				
		7				
		6				
		8				

